

7 F

Fumistería
Connecting flue pipe
Fumisterie

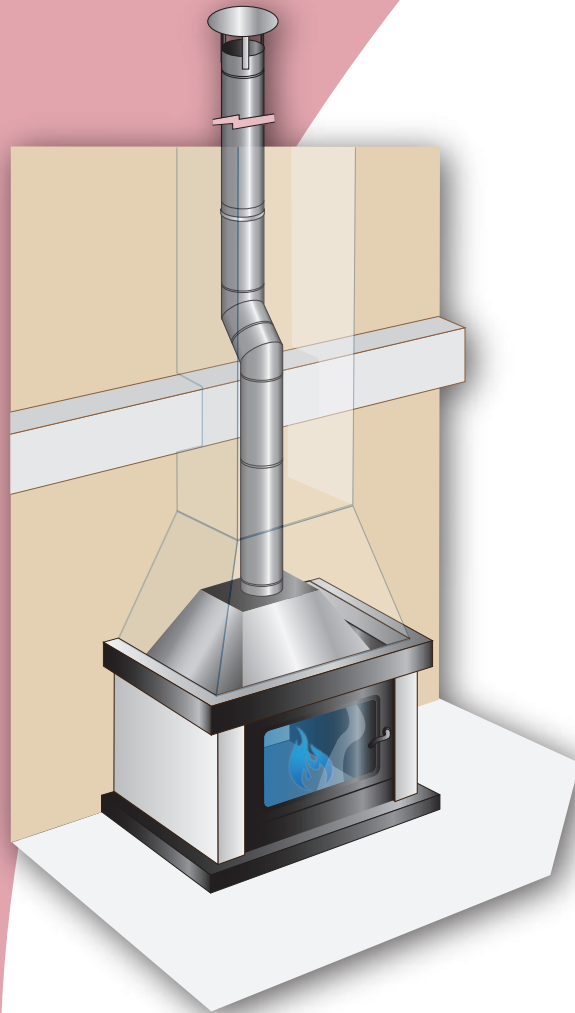

F.1

FUMISTERÍA INOXIDABLE
STAINLESS STEEL CONNECTING FLUE PIPE
FUMISTERIE INOXYDABLE

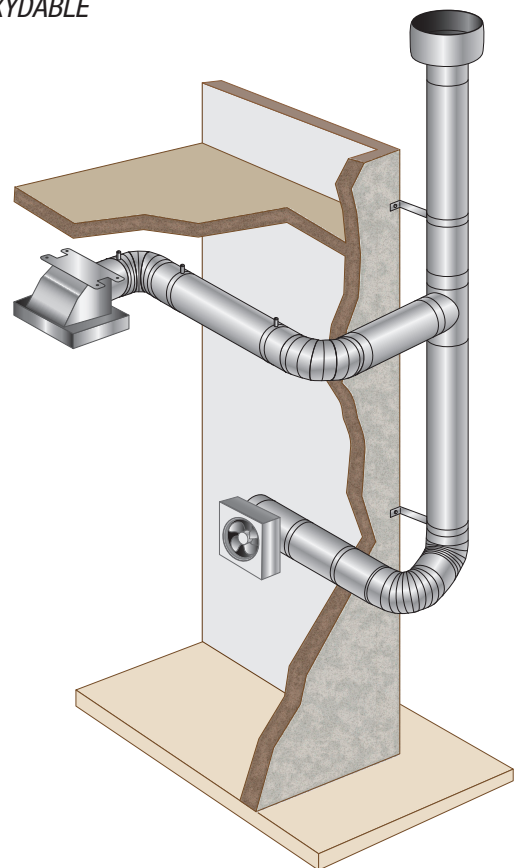

F.2

FUMISTERÍA GALVANIZADA
GALVANIZED CONNECTING FLUE PIPE
FUMISTERIE GALVANISÉE



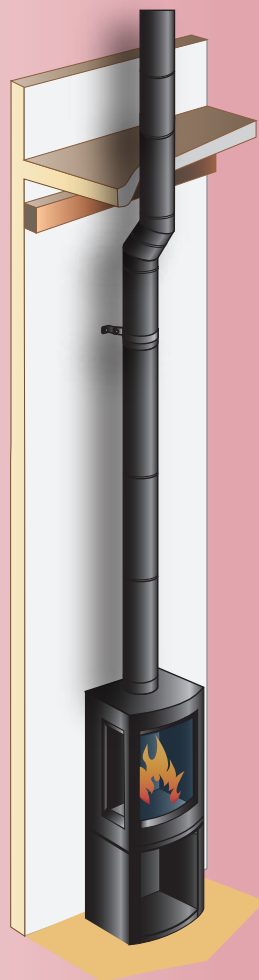

F.1

CE Especificaciones de acuerdo a la legislación europea en productos de construcción **CPR**
 Specifications according to EU product regulations of construction **CPR**
 Spécifications Selon la réglementation européenne concernant les produits de construction **CPR**

FUMISTERÍA INOXIDABLE
STAINLESS STEEL CONNECTING FLUE PIPE
FUMISTERIE INOXYDABLE

Espeor Thickness Épaisseur	→	ø80-120	0,4 mm
		ø125-175	0,5 mm
		ø200-400	0,8 mm



AISI 304L (1.4307) **2B** mate | matt | mat

EN 1856-2

- T600 N1 D Vm L20040 G(600) NM
- T600 N1 D Vm L20050 G(600) NM
- T600 N1 D Vm L20060 G(600) NM
- T600 N1 D Vm L20080 G(600) NM

F.2

FUMISTERÍA GALVANIZADA
GALVANIZED CONNECTING FLUE PIPE
FUMISTERIE GALVANISÉE

Espeor Thickness Épaisseur	→	ø80-100	0,4 mm
		ø110-150	0,5 mm
		ø120-175	0,8 mm
		ø200-400	1,0 mm

GALVA DX51D+Z200-100 MA C

F.3

FUMISTERÍA VITRIFICADA
VITREOUS ENAMEL CONNECTING FLUE PIPE
FUMISTERIE ÉMAILLÉE

Grosor Thickness Épaisseur	→	ø100-150	1,0 mm
		ø175-200	1,2 mm



VITRI-B DC01EK AM O brillante | bright | brillant

EN 1856-2

- T600 N2 D Vm L80050 O(600) NM
- T600 N2 D Vm L80080 O(600) NM

Grosor Thickness Épaisseur	→	ø120-200	1,2 mm
----------------------------------	---	----------------	---------------



VITRI-M DC01EK AM O mate | matt | mat

EN 1856-2

- T600 N2 D Vm L80080 O(600) NM

F.3

FUMISTERÍA VITRIFICADA
VITREOUS ENAMEL CONNECTING FLUE PIPE
FUMISTERIE ÉMAILLÉE

(brillante | bright | brillant)

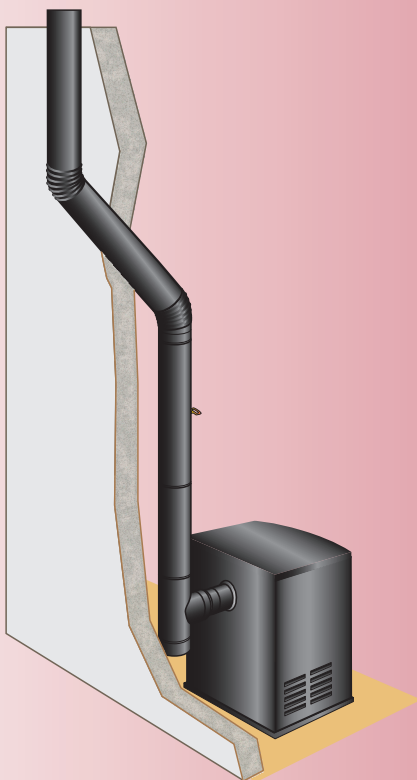

FUMISTERÍA VITRIFICADA
VITREOUS ENAMEL CONNECTING FLUE PIPE
FUMISTERIE ÉMAILLÉE









(mate | matt | mat)

Diámetro diameter diamètre Ø		80	100	120	125	130	150	175
Espesor Sheet thickness Épaisseur paroi		0,4			0,5			
Tubo Pipe <i>Conduit</i> 1.000 mm 	Ref.	5301080	5301100	5301120	5301125	5301130	5301150	5301175
	€/u U.	10	10	10	10	10	7	5
Tubo Pipe <i>Conduit</i> 500 mm 	Ref.	5302080	5302100	5302120	5302125	5302130	5302150	5302175
	€/u U.	10	10	10	10	10	5	5
Codo rizado estanco Ridged Elbow <i>tight</i> <i>Coude plissé étanche</i> 45° 	Ref.	5311080	5311100	5311120	5311125	5311130	5311150	5315175 *
	€/u U.	8	8	8	8	8	8	8
Codo rizado estanco Ridged Elbow <i>tight</i> <i>Coude plissé étanche</i> 90° 	Ref.	5313080	5313100	5313120	5313125	5313130	5313150	5316175 *
	€/u U.	4	4	4	4	4	4	4
Te 90° con tapa "T" piece 90° with Cover <i>Té 90° avec tampon</i> 	Ref.			5321120	5321125	5321130	5321150	5321175
	€/u U.			1	1	1	1	1
Sombrero antilluvia "Seta" "Seta" Rain Cap <i>Chapeau pare-pluie "Seta"</i> 	Ref.	5332080	5332100	5332120	5332125	5332130	5332150	5332175
	€/u U.	1	1	1	1	1	1	1
Sombrero antirretorno "Cerco" "Cerco" Antireturn Cap <i>Chapeau anti-refoulement "Cerco"</i> 	Ref.	5433080	5433100	5433120	5433125	5433130	5433150	5433175
	€/u U.	1	1	1	1	1	1	1
Abrazadera alicatar Wall mounting bracket <i>Collier à vis</i> 	Ref.	5471080	5471100	5471120	5471125	5471130	5471150	5471175
	€/u U.	1	1	1	1	1	1	1
Abrazadera empotrar Bracket with Leg <i>Collier à encastrer</i> 	Ref.	5472080	5472100	5472120	5472125	5472130	5472150	5472175
	€/u U.	1	1	1	1	1	1	1
Manguito Macho-Macho Hose connection Male-Male <i>Manchette de raccordement Mâle-Mâle</i> 200 mm 	Ref.		5351100	5351120	5351125	5351130	5351150	5351175
	€/u U.		1	1	1	1	1	1
Manguito Hembra-Hembra Hose connection Female-Female <i>Manchette de raccordement Femelle-Femelle</i> 200 mm 	Ref.		5352100	5352120	5352125	5352130	5352150	5352175
	€/u U.		1	1	1	1	1	1
Reducción Reduction Adapter I <i>Réduction</i> Ø 125 	Ref.			5441120				
	€/u U.			1				
Reducción Reduction Adapter I <i>Réduction</i> Ø 130	Ref.			5442120	5442125			
	€/u U.			1	1			
Reducción Reduction Adapter I <i>Réduction</i> Ø 150	Ref.			5443120	5443125	5443130		
	€/u U.			1	1	1		
Reducción Reduction Adapter I <i>Réduction</i> Ø 175	Ref.						5444150	
	€/u U.						1	
Reducción Reduction Adapter I <i>Réduction</i> Ø 200	Ref.						5445150	5445175
	€/u U.						1	1





















Ref.	5301150	Unidades de embalaje Packing units Unités d'emballage
€/u U.	7	

		Diámetro diameter diamètre Ø	200	225	250	300	350	400
		Espesor Sheet thickness Épaisseur paroi	0,8					
Tubo Pipe Conduit 1.000 mm		Ref.	5401200	5401225	5401250	5401300	5401350	5401400
		€/u U.	4	4	3	3	1	1
Tubo Pipe Conduit 500 mm		Ref.	5402200	5402225	5402250	5402300	5402350	5402400
		€/u U.	4	4	3	3	1	1
Codo Elbow Coude 45°		Ref.	5415200	5415225	5415250	5415300	5415350	5415400
		€/u U.	8	8	8	8	8	8
Codo Elbow Coude 90°		Ref.	5416200	5416225	5416250	5416300	5416350	5416400
		€/u U.	4	4	4	4	4	4
Te 90° con tapa "T" piece 90° with Cover Té 90° avec tampon		Ref.	5421200		5421250	5421300		
		€/u U.	1		1	1		
Sombbrero antilluvia "Seta" "Seta" Rain Cap Chapeau pare-pluie "Seta"		Ref.	5432200	5432225	5432250	5432300	5432350	5432400
		€/u U.	1	1	1	1	1	1
Sombbrero antiretorno "Cerco" "Cerco" Antireturn Cap Chapeau anti-refoulement "Cerco"		Ref.	5433200	5433225	5433250	5433300	5433350	5433400
		€/u U.	1	1	1	1	1	1
Abrazadera alicatar Wall mounting Bracket Collier à vis		Ref.	5471200	5471225	5471250	5471300	5471350	5471400
		€/u U.	1	1	1	1	1	1
Abrazadera empotrar Bracket with Leg Collier à encastrer		Ref.	5472200	5472225	5472250	5472300	5472350	5472400
		€/u U.	1	1	1	1	1	1
Manguito Macho-Macho Hose connection Male-Male Manchette de raccordement Mâle-Mâle 200 mm		Ref.	5451200					
		€/u U.	1					
Manguito Hembra-Hembra Hose connection Female-Female Manchette de raccordement Femelle-Femelle 200 mm		Ref.	5452200					
		€/u U.	1					
Reducción Reduction Adapter Réduction Ø 225		Ref.	5441200					
		€/u U.	1					
Reducción Reduction Adapter Réduction Ø 250		Ref.	5442200					
		€/u U.	1					
Reducción Reduction Adapter Réduction Ø 300		Ref.			5443250			
		€/u U.			1			
Reducción Reduction Adapter Réduction Ø 350		Ref.				5444300		
		€/u U.				1		
Reducción Reduction Adapter Réduction Ø 400		Ref.					5445350	
		€/u U.					1	

7

		Diámetro diameter diamètre Ø		80	100	110	120	125	130	140	150
		Espesor Sheet thickness Épaisseur paroi		0,4		0,5					
Tubo Pipe Conduit 1.000 mm		Ref.		5101080	5101100	5101110	5101120	5101125	5101130	5101140	5101150
		€/u U.		10	10	10	10	10	10	7	7
Codo rizado estanco Ridged Elbow tight Coude plissé étanche 45°		Ref.			5111100		5111120	5111125	5111130		5111150
		€/u U.			8		8	8	8		8
Codo rizado estanco Ridged Elbow tight Coude plissé étanche 70°		Ref.		5112080	5112100	5112110	5112120	5112125	5112130	5112140	5112150
		€/u U.		5	5	5	5	5	5	5	5
Codo rizado estanco Ridged Elbow tight Coude plissé étanche 90°		Ref.		5113080	5113100	5113110	5113120	5113125	5113130	5113140	5113150
		€/u U.		4	4	4	4	4	4	4	4
Te 90° con tapa "T" piece 90° with Cover Té 90° avec tampon		Ref.				5121110	5121120				
		€/u U.				1	1				
Sombrero antilluvia "Seta" "Seta" Rain Cap Chapeau pare-pluie "Seta"		Ref.		5132080	5132100	5132110	5132120	5132125	5132130	5132140	5132150
		€/u U.		1	1	1	1	1	1	1	1
Sombrero antiretorno "Cerco" "Cerco" Antireturn Cap Chapeau anti-refoulement "Cerco"		Ref.			5233100	5233110	5233120	5233125	5233130	5233140	5233150
		€/u U.			1	1	1	1	1	1	1
Abrazadera alicatar Wall mounting Bracket Collier à vis		Ref.		5271080	5271100	5271110	5271120	5271125	5271130	5271140	5271150
		€/u U.		1	1	1	1	1	1	1	1
Abrazadera empotrar Bracket with Leg Collier à encastrer		Ref.		5272080	5272100	5272110	5272120	5272125	5272130	5272140	5272150
		€/u U.		1	1	1	1	1	1	1	1
Manguito Macho-Macho Hose connection Male-Male Manchette de raccordement Mâle-Mâle 200 mm		Ref.			5151100	5151110	5151120	5151125	5151130		5151150
		€/u U.			1	1	1	1	1		1
Manguito Hembra-Hembra Hose connection Female-Female Manchette de raccordement Femelle-Femelle 200 mm		Ref.			5152100	5152110	5152120	5152125	5152130		5152150
		€/u U.			1	1	1	1	1		1
Reducción Reduction Adapter Réduction Ø 100		Ref.		5241080							
		€/u U.		1							
Reducción Reduction Adapter Réduction Ø 110		Ref.			5242100						
		€/u U.			1						
Reducción Reduction Adapter Réduction Ø 120		Ref.			5243100	5243110					
		€/u U.			1	1					
Reducción Reduction Adapter Réduction Ø 125		Ref.					5244120				
		€/u U.					1				
Reducción Reduction Adapter Réduction Ø 130		Ref.					5245120				
		€/u U.					1				
Reducción Reduction Adapter Réduction Ø 140		Ref.				5246110	5246120				
		€/u U.				1	1				
Reducción Reduction Adapter Réduction Ø 150		Ref.					5242120				
		€/u U.					1				

Ref.	5101150	Unidades de embalaje Packing units Unités d'emballage
€/u U.	7	

Diámetro diameter diamètre Ø		120	125	130	150	175	200	225	250	300	350	400
Espesor Sheet thickness Épaisseur-paroi		0,8					1,0					
Tubo Pipe <i>Conduit</i> 1.000 mm 	Ref.	5201120	5201125	5201130	5201150	5201175	5201200	5201225	5201250	5201300	5201350	5201400
	€/u U.	10	10	5	5	5	4	4	3	3	1	1
Codo Elbow <i>Coude</i> 45° 	Ref.	5215120	5215125	5215130	5215150	5215175	5215200	5215225	5215250	5215300	5215350	5215400
	€/u U.	8	8	8	8	8	8	8	8	8	8	8
Codo Elbow <i>Coude</i> 90° 	Ref.	5216120	5216125	5216130	5216150	5216175	5216200	5216225	5216250	5216300	5216350	5216400
	€/u U.	4	4	4	4	4	4	4	4	4	4	4
Te 90° con tapa "T" piece 90° with Cover <i>Té 90° avec tampon</i> 	Ref.				5221150	5221175	5221200					
	€/u U.				1	1	1					
Sombrero antilluvia "Seta" "Seta" Rain Cap <i>Chapeau pare-pluie "Seta"</i> 	Ref.	5232120	5232125	5232130	5232150	5232175	5232200	5232225	5232250	5232300	5232350	5232400
	€/u U.	1	1	1	1	1	1	1	1	1	1	1
Sombrero antiretorno "Cerco" "Cerco" Antireturn Cap <i>Chapeau anti-refoulement "Cerco"</i> 	Ref.	5233120	5233125	5233130	5233150	5233175	5233200	5233225	5233250	5233300	5233350	5233400
	€/u U.	1	1	1	1	1	1	1	1	1	1	1
Abrazadera alicatar Wall mounting Bracket <i>Collier à vis</i> 	Ref.	5271120	5271125	5271130	5271150	5271175	5271200	5271225	5271250	5271300	5271350	5271400
	€/u U.	1	1	1	1	1	1	1	1	1	1	1
Abrazadera empotrar Bracket with Leg <i>Collier à encastrer</i> 	Ref.	5272120	5272125	5272130	5272150	5272175	5272200	5272225	5272250	5272300	5272350	5272400
	€/u U.	1	1	1	1	1	1	1	1	1	1	1
Manguito Macho-Macho Hose connection Male-Male <i>Manchette de raccordement Mâle-Mâle</i> 200 mm 	Ref.	5251120	5251125	5251130	5251150	5251175	5251200		5251250	5251300		
	€/u U.	1	1	1	1	1	1		1	1		
Manguito Hembra-Hembra Hose connection Female-Female <i>Manchette de raccordement Femelle-Femelle</i> 200 mm 	Ref.	5252120	5252125	5252130	5252150	5252175	5252200		5252250	5252300		
	€/u U.	1	1	1	1	1	1		1	1		
Reducción Reduction Adapter Réduction Ø 125 	Ref.	5244120										
	€/u U.	1										
Reducción Reduction Adapter Réduction Ø 130 	Ref.	5245120										
	€/u U.	1										
Reducción Reduction Adapter Réduction Ø 150 	Ref.	5242120		5242130								
	€/u U.	1		1								
Reducción Reduction Adapter Réduction Ø 175 	Ref.				5243150							
	€/u U.				1							
Reducción Reduction Adapter Réduction Ø 200 	Ref.				5244150	5244175						
	€/u U.				1	1						
Reducción Reduction Adapter Réduction Ø 225 	Ref.						5245200					
	€/u U.						1					
Reducción Reduction Adapter Réduction Ø 250 	Ref.						5246200					
	€/u U.						1					
Reducción Reduction Adapter Réduction Ø 300 	Ref.							5247250				
	€/u U.							1				
Reducción Reduction Adapter Réduction Ø 350 	Ref.									5248300		
	€/u U.									1		
Reducción Reduction Adapter Réduction Ø 400 	Ref.										5249350	
	€/u U.										1	

7

Gama negro brillante | Bright black range | Gamme noir brillant

VITRIFICADO A 90°		90° VITRIFIED		VITRIFIÉ À 90°				
Diámetro / diameter / diamètre Ø		100	110	120	150	175	200	
Espesor total / Total thickness / Épaisseur total		1				1,2		
Tubo Pipe Conduit 1.000 mm		Ref.	5501100	5501110	5501120	5501150	5501175	5501200
		€/u U.	6	6	6	3	2	2
Tubo Pipe Conduit 500 mm		Ref.	5502100	5502110	5502120	5502150	5502175	5502200
		€/u U.	12	12	12	6	4	4
Tubo con llave Pipe with Tap Conduit clé 1.000 mm		Ref.	5505100	5505110	5505120	5505150	5505175	5505200
		€/u U.	6	6	6	3	2	2
Codo rizado Ridged Elbow Coude plissé 45°		Ref.	5511100	5511110	5511120	5511150	5515175 *	5515200 *
		€/u U.	15	15	15	10	10	10
Codo rizado Ridged Elbow Coude plissé 70°		Ref.	5512100	5512110	5512120	5512150		
		€/u U.	15	15	15	10		
Codo rizado Ridged Elbow Coude plissé 90°		Ref.	5513100	5513110	5513120	5513150	5516175 *	5516200 *
		€/u U.	12	12	12	8	8	8
Te 90° con tapa "T" piece 90° with Cover Té 90° avec tampon		Ref.		5521110	5521120	5521150	5521175	5521200
		€/u U.		10	10	6	4	4
Plafón (rosetón) Rosette Rosace		Ref.	5561100	5561110	5561120	5561150	5561175	5561200
		€/u U.	1	1	1	1	1	1
Manguito Macho-Macho Hose connection Male-Male Manchette de raccordement Mâle-Mâle 200 mm		Ref.	5551100	5551110	5551120	5551150	5551175	5551200
		€/u U.	1	1	1	1	1	1
Manguito Hembra-Hembra Hose connection Female-Female Manchette de raccordement Femelle-Femelle 200 mm		Ref.	5552100	5552110	5552120	5552150	5552175	5552200
		€/u U.	1	1	1	1	1	1
Reducción Reduction Adapter I Réduction Ø 110		Ref.	5541100					
		€/u U.	1					
Reducción Reduction Adapter I Réduction Ø 120		Ref.	5542100	5542110				
		€/u U.	1	1				
Reducción Reduction Adapter I Réduction Ø 140		Ref.			5543120			
		€/u U.			1			
Reducción Reduction Adapter I Réduction Ø 150		Ref.			5544120			
		€/u U.			1			
Reducción Reduction Adapter I Réduction Ø 175		Ref.				5545150		
		€/u U.				1		
Reducción Reduction Adapter I Réduction Ø 200		Ref.				5546150	5546175	
		€/u U.				1	1	

Ref.	5501150	Unidades de embalaje Packing units Unités d'emballage
€/u U.	7	

Gama negro mate | Matt black range | Gamme noir mat

VITRIFICADO A 900°C

900°C VITRIFIED

VITRIFIÉ À 900°C

		Diámetro / diameter / diamètre Ø	120	125	150	175	200
		Espesor total / Total thickness / Épaisseur total	1,2				
Tubo Pipe Conduit 1.000 mm 	Ref.	5601120	5601125	5601150	5601175	5601200	
	€/u U.	6	5	3	2	2	
Tubo Pipe Conduit 500 mm 	Ref.	5602120	5602125	5602150	5602175	5602200	
	€/u U.	12	10	6	4	4	
Tubo con llave Pipe with Tap Conduit clé 1.000 mm 	Ref.	5605120	5605125	5605150	5605175	5605200	
	€/u U.	6	5	3	2	2	
Tubo telescópico Insertable pipe Conduit télescopique 200 mm 	Ref.	5606120	5606125	5606150	5606175	5606200	
	€/u U.	1	1	1	1	1	
Codo Elbow Coude 45° 	Ref.	5615120	5615125	5615150	5615175	5615200	
	€/u U.	10	10	10	10	10	
Codo Elbow Coude 90° 	Ref.	5616120	5616125	5616150	5616175	5616200	
	€/u U.	8	8	8	8	8	
Te 90° con tapa "T" piece 90° with Cover Té 90° avec tampon 	Ref.	5621120	5621125	5621150	5621175	5621200	
	€/u U.	10	6	6	4	4	
Plafón (rosetón) Rosette Rosace 	Ref.	5661120	5661125	5661150	5661175	5661200	
	€/u U.	1	1	1	1	1	