

5 DP50

Doble Pared 50 mm
50 mm Double Wall
Double Paroi 50 mm

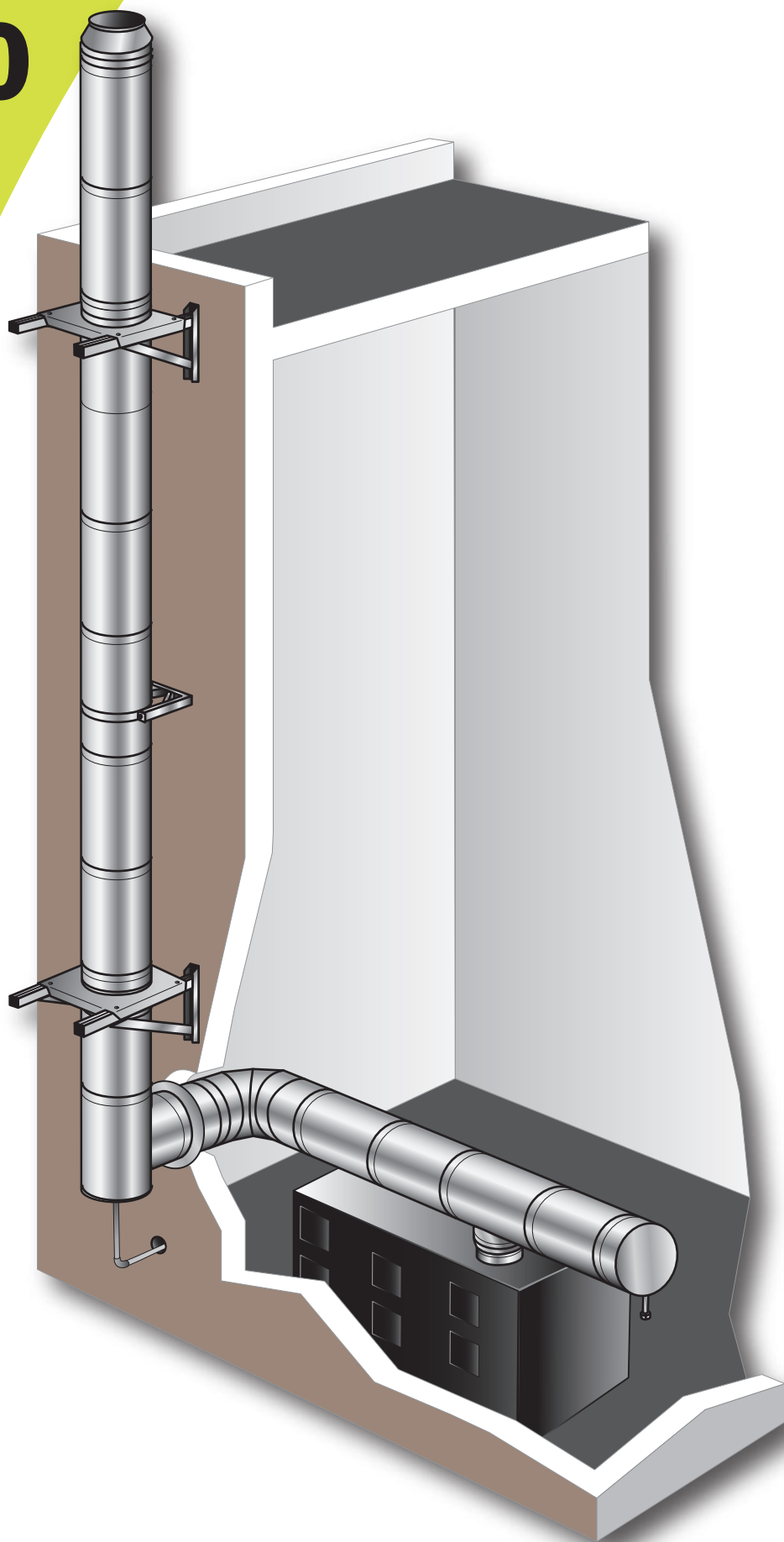

CE Especificaciones de acuerdo a la legislación europea en productos de construcción **CPR**
 Specifications according to EU product regulations of construction **CPR**
*Spécifications Selon la réglementation européenne concernant les produits de construction **CPR***

Espesor Thickness Épaisseur		Ø130-250	0,4 mm
		Ø300-400	0,5 mm
		Ø450-600	0,6 mm

Espesor del aislante Insulation thickness Épaisseur d'isolation		50 mm	Lana de roca Rock wool Laine de roche
---	--	-------	---



interior y exterior | inside and outside | intérieur et extérieur

AISI 304

(1.4301) **2R**

UNE-EN 1856-1 : 2010

T200 P1 W Vm L20040 O(00)

T450 N1 W Vm L20040 O(15)

T600 N1 W Vm L20040 O(20)

T600 N1 D Vm L20040 G(45)



interior | inside | intérieur

exterior | outside | extérieur

* **AISI 316L**

(1.4404) **2R**

AISI 304

(1.4301) **2R**

UNE-EN 1856-1 : 2010

* Consultar Departamento Comercial
 Consult Sales Department
Consulter le Département Commercial

Notas: | Notes:

Productos con clasificación EI 30 y EI 45.
 Products with EI 30 and EI 45 classification.
Produits classés EI 30 et EI 45.

Para diámetros superiores a Ø300 mm, la distancia a los materiales combustibles se debe incrementar mediante un coeficiente.

For diameters more than Ø300 mm, the distance to combustible materials must be increased by a coefficient.

Pour les diamètres supérieurs à Ø300 mm, la distance par rapport aux matériaux combustibles doit être augmentée par un coefficient.

**XX Distancia | Distance: x1,5 (Ø350-450)
 x2 (Ø500-600)**

Junta incluida.
 Gasket included.
 Joint inclus.

Módulo lineal | Linear module | Élément droit

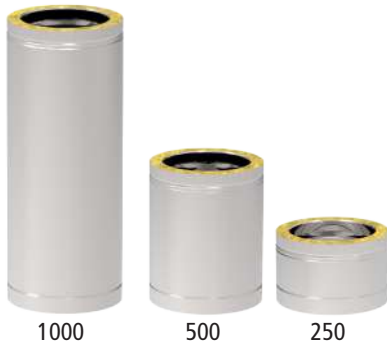

ØDi mm **130 150 180 200 250 300 350 400**

L 1000 mm

AISI	Ref.	4500000	4500001	4500002	4500003	4500004	4500005	4500006	4500007
304-304	€ U.	1	1	1	1	1	1	1	1

L 500 mm

AISI	Ref.	4500020	4500021	4500022	4500023	4500024	4500025	4500026	4500027
304-304	€ U.	1	1	1	1	1	1	1	1

L 250 mm

AISI	Ref.	4500040	4500041	4500042	4500043	4500044	4500045	4500046	4500047
304-304	€ U.	1	1	1	1	1	1	1	1

Módulo extensible | Extendable module | Élément télescopique



ØDi mm **130 150 180 200 250 300 350 400**

Lmin 500 mm - Lmax 900 mm

AISI	Ref.	4500100	4500101	4500102	4500103	4500104	4500105	4500106	4500107
304-304	€ U.	1	1	1	1	1	1	1	1

Lmin 335 mm - Lmax 565 mm

AISI	Ref.	4500080	4500081	4500082	4500083	4500084	4500085	4500086	4500087
304-304	€ U.	1	1	1	1	1	1	1	1

Lmin 200 mm - Lmax 300 mm

AISI	Ref.	4500060	4500061	4500062	4500063	4500064	4500065	4500066	4500067
304-304	€ U.	1	1	1	1	1	1	1	1

Codo | Elbow | Coude **15°**



ØDi mm **130 150 180 200 250 300 350 400**

AISI	Ref.	4500120	4500121	4500122	4500123	4500124	4500125	4500126	4500127
304-304	€ U.	1	1	1	1	1	1	1	1

Medidas | Measurements | Mesures

	H	12	13	13	13	14	15	30	31
V		136	139	143	145	152	158	278	285

Codo | Elbow | Coude **30°**



ØDi mm **130 150 180 200 250 300 350 400**

AISI	Ref.	4500140	4500141	4500142	4500143	4500144	4500145	4500146	4500147
304-304	€ U.	1	1	1	1	1	1	1	1

Medidas | Measurements | Mesures

	H	32	33	35	36	40	43	90	93
V		161	166	173	178	191	203	384	396

Codo | Elbow | Coude **45°**



ØDi mm **130 150 180 200 250 300 350 400**

AISI	Ref.	4500160	4500161	4500162	4500163	4500164	4500165	4500166	4500167
304-304	€ U.	1	1	1	1	1	1	1	1

Medidas | Measurements | Mesures

	H	54	57	61	63	70	77	151	159
V		178	185	195	202	219	236	416	434

Codo | Elbow | Coude **90°**



ØDi mm **130 150 180 200 250 300 350 400**

AISI	Ref.	4500180	4500181	4500182	4500183	4500184	4500185	4500186	4500187
304-304	€ U.	1	1	1	1	1	1	1	1

Medidas | Measurements | Mesures

	H	212	222	237	247	272	297	427	451
V		160	170	184	194	217	241	482	507

Ref.	4500001	Unidades de embalaje Packing units Unités d'emballage
€ U.	1	



Abrazadera de unión incluida en todas las piezas.
Connection bracket included in all parts.
Collier de fixation inclus dans toutes les pièces.



Junta incluida.
Gasket included.
Joint inclus.

450 500 550 600

4500008	4500009	4500010	4500011
1	1	1	1

4500028	4500029	4500030	4500031
1	1	1	1

4500048	4500049	4500050	4500051
1	1	1	1

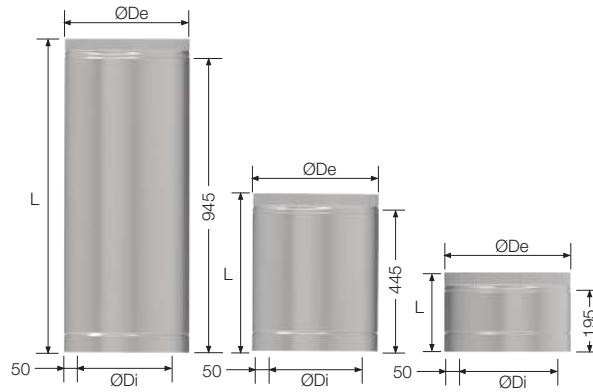

450 500 550 600

4500108	4500109	4500110	4500111
1	1	1	1

4500088	4500089	4500090	4500091
1	1	1	1

4500068	4500069	4500070	4500071
1	1	1	1

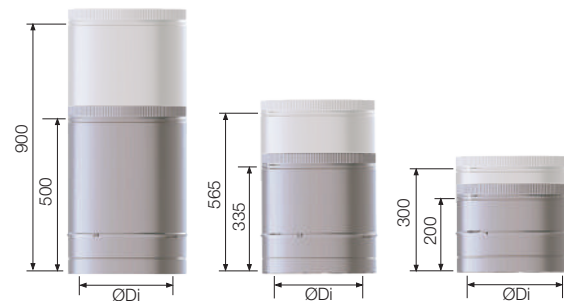

450 500 550 600

4500128	4500129	4500130	4500131
1	1	1	1

32	33	34	35
291	298	304	311

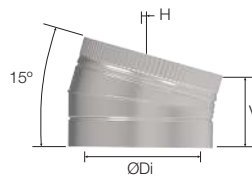

450 500 550 600

4500148	4500149	4500150	4500151
1	1	1	1

97	100	103	107
409	421	434	446

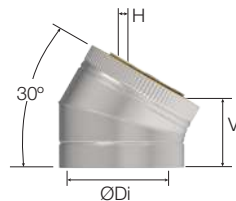

450 500 550 600

4500168	4500169	4500170	4500171
1	1	1	1

166	173	181	188
451	469	487	504

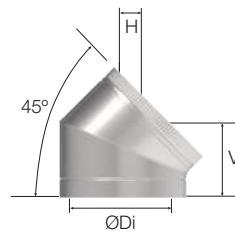

450 500 550 600

4500188	4500189	4500190	4500191
1	1	1	1

475	498	522	546
532	557	582	607

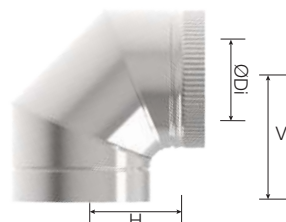

Te | "T" piece | Té **90° ***



		ØDi mm							
		130	150	180	200	250	300	350	400
AISI 304-304	Ref.	4500200	4500201	4500202	4500203	4500204	4500205	4500206	4500207
	€ U.	1	1	1	1	1	1	1	1

Medidas | Measurements | Mesures

	L	345	365	413	445	465	545	650	700
	H	208	218	233	243	268	293	294	320
	V	194	204	228	244	254	279	350	375

Te | "T" piece | Té **135° ***



		ØDi mm							
		130	150	180	200	250	300	350	400
AISI 304-304	Ref.	4500220	4500221	4500222	4500223	4500224	4500225	4500226	4500227
	€ U.	1	1	1	1	1	1	1	1

Medidas | Measurements | Mesures

	L	435	465	505	535	605	675	750	813
	H <td>268</td> <td>285</td> <td>311</td> <td>328</td> <td>371</td> <td>413</td> <td>458</td> <td>500</td>	268	285	311	328	371	413	458	500
	V <td>268</td> <td>285</td> <td>311</td> <td>123</td> <td>141</td> <td>158</td> <td>268</td> <td>250</td>	268	285	311	123	141	158	268	250

Tapa | Cap | Tampon



		ØDi mm							
		130	150	180	200	250	300	350	400
AISI 304-304	Ref.	4500240	4500241	4500242	4500243	4500244	4500245	4500246	4500247
	€ U.	1	1	1	1	1	1	1	1

Tapa purga | Condensate cap | Tampon purge



		ØDi mm							
		130	150	180	200	250	300	350	400
AISI 304-304	Ref.	4500260	4500261	4500262	4500263	4500264	4500265	4500266	4500267
	€ U.	1	1	1	1	1	1	1	1

Medidas | Measurements | Mesures

	ØG	1/2"	3/4"	3/4"	3/4"	3/4"	1"	1"	1"
--	----	------	------	------	------	------	----	----	----

Módulo de inspección con tapa | Inspection module with cap | Module inspection avec tampon



		ØDi mm							
		130	150	180	200	250	300	350	400
AISI 304-304	Ref.	4500280	4500281	4500282	4500283	4500284	4500285	4500286	4500287
	€ U.	1	1	1	1	1	1	1	1

Medidas | Measurements | Mesures

	L	345	365	415	450	450	450	450	450
	ØT	130	150	180	200	250	200	200	200

Tapa de inspección | Inspection plug | Trappe d'inspection **200°C / 200 Pa**



Resistente a la humedad
Moisture resistant
Insensible à l'humidité

		ØDi mm							
		130	150	180	200	250	300	350	400
AISI 304	Ref.	5003267	5003268	5003269	5003270	5003271	5003270		
	€ U.	1	1	1	1	1	1		

Medidas | Measurements | Mesures

	ØT	130	150	180	200	250	200		
--	----	-----	-----	-----	-----	-----	-----	--	--

Tapa de inspección | Inspection plug | Trappe d'inspection **450°C / 40 Pa**



Para combustibles sólidos
For solid fuels
Pour combustibles solides

		ØDi mm							
		130	150	180	200	250	300	350	400
AISI 304	Ref.	5003393	5003394	5003395	5003396	5003397	5003396		
	€ U.	1	1	1	1	1	1		

Ref.	4500201	Unidades de embalaje Packing units Unités d'emballage
€ U.	1	



Abrazadera de unión incluida en todas las piezas.
Connection bracket included in all parts.
Collier de fixation inclus dans toutes les pièces.



Junta incluida.
Gasket included.
Joint inclus.

450	500	550	600
-----	-----	-----	-----

4500208	4500209	4500210	4500211
1	1	1	1

750	800	850	900
345	370	395	420
345	370	395	420

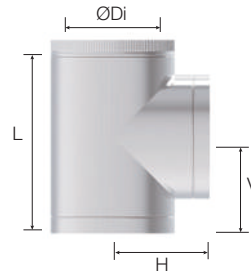

* No incluye tapa
Cover not included
Couvercle non inclus

450	500	550	600
-----	-----	-----	-----

4500228	4500229	4500230	4500231
1	1	1	1

884	955	1025	1100
543	586	629	672
232	213	196	178

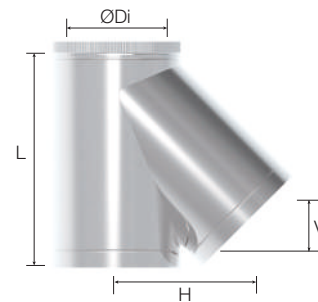

* No incluye tapa
Cover not included
Couvercle non inclus

450	500	550	600
-----	-----	-----	-----

4500248	4500249	4500250	4500251
1	1	1	1

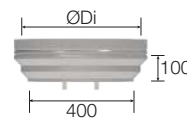

Sifón | Siphon | Siphon

Ref.	4030741
€ U.	1

max. 160° C

450	500	550	600
-----	-----	-----	-----

4500268	4500269	4500270	4500271
1	1	1	1

1"	1"	1"	1"
----	----	----	----

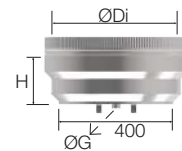

450	500	550	600
-----	-----	-----	-----

4500288	4500289	4500290	4500291
1	1	1	1

450	450	450	450
200	200	200	200



450	500	550	600
-----	-----	-----	-----

5003270			
1			

200			
-----	--	--	--

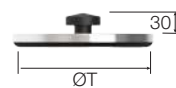

450	500	550	600
-----	-----	-----	-----

5003396			
1			

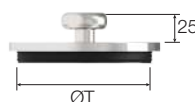

5

Sombrero antilluvia | Rain cap | *Chapeau pare-pluie*



ØDi mm **130 150 180 200 250 300 350 400**

AISI	Ref.	4500300	4500301	4500302	4500303	4500304	4500305	4500306	4500307
304-304	€ U.	1	1	1	1	1	1	1	1

Medidas | Measurements | Mesures

	V	143	143	143	180	180	193	193	193
	ØDs	350	400	450	500	550	600	650	700

Sombrero bicónico | Jet cap | *Chapeau jet*



ØDi mm **130 150 180 200 250 300 350 400**

AISI	Ref.	4500360	4500361	4500362	4500363	4500364	4500365	4500366	4500367
304-304	€ U.	1	1	1	1	1	1	1	1

Medidas | Measurements | Mesures

	ØDS	155	180	215	240	300	360	420	480
	ØDC	233	268	313	353	440	525	615	700
	V	357	387	437	467	547	627	707	787

Sombrero salida libre | Exhaust high cone | *Cône de finition haute*



ØDi mm **130 150 180 200 250 300 350 400**

AISI	Ref.	4500320	4500321	4500322	4500323	4500324	4500325	4500326	4500327
304-304	€ U.	1	1	1	1	1	1	1	1

Sombrero pico flauta | Lateral cap | *Chapeau de flûte*



ØDi mm **130 150 180 200 250 300 350 400**

AISI	Ref.	4500340	4500341	4500342	4500343	4500344	4500345	4500346	4500347
304-304	€ U.	1	1	1	1	1	1	1	1

Abrazadera unión ancha | Wide connection bracket | *Collier de fixation large*



ØDi mm **130 150 180 200 250 300 350 400**

AISI	Ref.	5005363	5005364	5005363	5005364	5005365	5005366	5005367	5005368
304	€ U.	1	1	1	1	1	1	1	1

ØDe **230 250 280 300 350 400 450 500**

Junta silicona | Silicone gasket | *Joint silicone*



ØDi mm **130 150 180 200 250 300 350 400**

Ref.	5003951	5003952	5003953	5003954	5003957	5003958	5003959	5003960
€/u	U.	10	10	10	10	10	5	5

Junta cerámica autoadhesiva | Self-adhesive ceramic gasket | *Joint autoadhésif en céramique* **600° C**



Ref.	2053351
€/m	m. 1

Medidas | Measurements | Mesures

	Ø m	80	100	110	125	130	150	180	200
	m	0,25	0,31	0,35	0,39	0,41	0,47	0,57	0,63

(desarrollo | unfolding | déroulage)

Ref.	4500301	Unidades de embalaje Packing units Unités d'emballage
€/u	U. 1	



Abrazadera de unión incluida en todas las piezas.
Connection bracket included in all parts.
Collier de fixation inclus dans toutes les pièces.



Junta incluida.
Gasket included.
Joint inclus.

450	500	550	600
4500308	4500309	4500310	4500311
1	1	1	1

193	193	193	193
750	800	850	900

450	500	550	600
4500368	4500369	4500370	4500371
1	1	1	1

540	600	660	720
790	885	980	1075
867	947	1027	1107

450	500	550	600
4500328	4500329	4500330	4500331
1	1	1	1

450	500	550	600
4500348	4500349	4500350	4500351
1	1	1	1

450	500	550	600
5005569	5005570	5005571	5005572
1	1	1	1
550	600	650	700

450	500	550	600
5005716	5005717	5005718	5005719
1	1	1	1

230	250	300	350	400
0,72	0,79	0,94	1,10	1,26

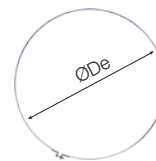
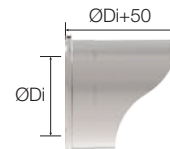
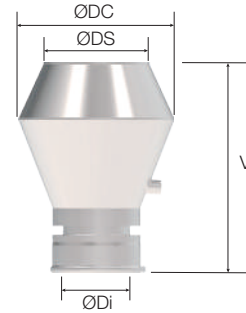
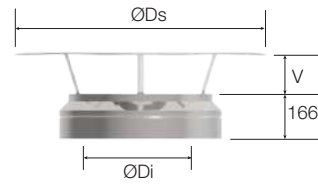

5

Lubricante silicona | Silicone lubricant | *Graisse silicone*



150ml

Ref.	5002932
€/u	U. 1

Adaptador a campana | Hood adapter | *Adaptateur pour hotte*



		ØDi mm							
		130	150	180	200	250	300	350	400
AISI 304-304	Ref.	4500400	4500401	4500402	4500403	4500404	4500405	4500406	4500407
	€ U.	1	1	1	1	1	1	1	1
Medidas Measurements Mesures									
	Ød2	163	183	208	239	289	339	389	441
	Ød3	183	203	228	263	313	363	413	473
	qxØt	5x7	5x7	6x7	6x9	8x9	10x9	12x9	12x9

Adaptador DP-DP50 | DW-DW50 adapter | *Adaptateur DP-DP50*



		ØDi mm							
		130	150	180	200	250	300	350	400
AISI 304-304	Ref.	4500420	4500421	4500422	4500423	4500424	4500425	4500426	4500427
	€ U.	1	1	1	1	1	1	1	1

Adaptador DP50-DP | DW50-DW adapter | *Adaptateur DP50-DP*



		ØDi mm							
		130	150	180	200	250	300	350	400
AISI 304-304	Ref.	4500440	4500441	4500442	4500443	4500444	4500445	4500446	4500447
	€ U.	1	1	1	1	1	1	1	1

Abrazadera mural exterior | External wall bracket | *Collier support mural extérieur **



Ø130-300

Ø350-600

* Opción regulable: añadir Prolongación mural (ver pág. 132)
Adjustable option: add Wall extension (see page 132)
Option réglable: ajouter Rallonge murale (voir page 132)

		ØDi mm							
		130	150	180	200	250	300	350	400
AISI 304	Ref.	4019880	4019881	4031702	4019882	4020326	4020327	4031696	4031697
	€ U.	1	1	1	1	1	1	1	1
	ØDe	230	250	280	300	350	400	450	500

Abrazadera mural interior | Interior wall bracket | *Collier support mural intérieur **



Ø130-400

Ø450-600

* Opción regulable: añadir Prolongación mural (ver pág. 132)
Adjustable option: add Wall extension (see page 132)
Option réglable: ajouter Rallonge murale (voir page 132)

		ØDi mm							
		130	150	180	200	250	300	350	400
AISI 304	Ref.	5001351	2500042	-	2500043	2500510	2500044	4035019	4035066
	€/u U.	2	2	-	2	2	2	1	1
Medidas Measurements Mesures									
	A	190	230	-	230	300	300	-	-
	B	-	-	-	-	-	-	-	-
	ØDe	230	250	280	300	350	400	450	500

Abrazadera de vientos | Roof brace band | *Bride pour hauban*



		ØDi mm							
		130	150	180	200	250	300	350	400
AISI 304	Ref.	2700214	2700354	4014614	2700403	2700323	2700418	4014608	4014609
	€ U.	1	1	1	1	1	1	1	1
	ØDe	230	250	280	300	350	400	450	500

Ref.	4500401	Unidades de embalaje Packing units Unités d'emballage
€/u	1	



Abrazadera de unión incluida en todas las piezas.
Connection bracket included in all parts.
Collier de fixation inclus dans toutes les pièces.



Junta incluida.
Gasket included.
Joint inclus.

450	500	550	600
-----	-----	-----	-----

4500408	4500409	4500410	4500411
1	1	1	1

491	541	591	641
523	573	623	673
14x9	14x9	16x9	18x9

450	500	550	600
-----	-----	-----	-----

4500428	4500429	4500430	4500431
1	1	1	1

450	500	550	600
-----	-----	-----	-----

4500448	4500449	4500450	4500451
1	1	1	1

450	500	550	600
-----	-----	-----	-----

4031698	4031699	4031700	4031701
1	1	1	1
550	600	650	700

450	500	550	600
-----	-----	-----	-----

4035067	4035068	4035069	4035070
1	1	1	1

-	-	-	-
-	-	-	-

550	600	650	700
-----	-----	-----	-----

450	500	550	600
-----	-----	-----	-----

4014610	4014611	4014612	4014613
1	1	1	1

550	600	650	700
-----	-----	-----	-----

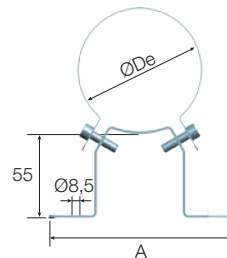
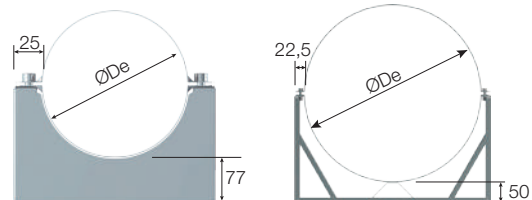
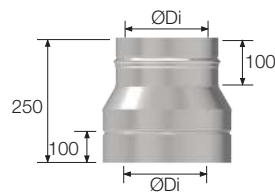
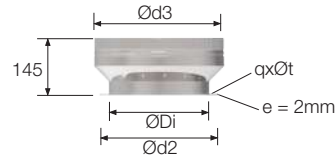

5

Soporte mural intermedio | Intermediate wall support | *Support mural intermédiaire* *



		ØDi mm							
		130	150	180	200	250	300	350	400
AISI 304-304	Ref.	4500380	4500381	4500382	4500383	4500384	4500385	4500386	4500387
	€ U.	1	1	1	1	1	1	1	1

Medidas | Measurements | Mesures

	A	263	283	313	333	383	433	483	533
	B	343	363	343	413	463	513	563	613

* No incluye escuadras | Square supports not included | *Équerres de support non inclus*

Soporte mural universal | Universal wall support | *Support mural universel* *

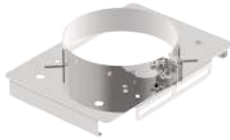

		ØDi mm							
		130	150	180	200	250	300	350	400
AISI 304	Ref.	4026053	4026054	4026058	4026059	4026060	4026061	4026062	4026063
	€ U.	1	1	1	1	1	1	1	1

Medidas | Measurements | Mesures

	A	263	283	313	333	383	435	485	535
	B	343	363	393	413	463	515	565	615

ØDe	230	250	280	300	350	400	450	500
-----	-----	-----	-----	-----	-----	-----	-----	-----

* No incluye escuadras | Square supports not included | *Équerres de support non inclus*

Escuadra de soporte (2 unidades) | Square support (2 units) | *Équerre de support (2 unités)*



		Pequeña* Small* Petit*	Mediana* Medium* Moyen*	Grande* Large* Grand*
AISI 304	Ref.	4019925	4019926	4019927
	€ Kit	1	1	1

Medidas | Measurements | Mesures

	L	245	360	515
	H	290	430	610

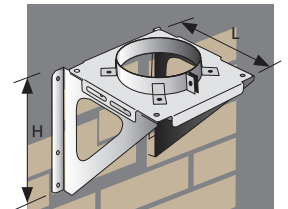

Escuadra con soporte mural
Square with wall support
Équerre avec support mural

* Consultar el tamaño adecuado en la página 143 | Refer to the appropriate size on page 143 | *Voir la taille appropriée à la page 143*

Soporte a techo regulable | Adjustable roof support | *Support au toit réglable*



		ØDi mm							
		130	150	180	200	250	300	350	400
AISI 304	Ref.	4013295	4012428	4040053	4015588	4015660	4014552	4040054	4040055
	€ U.	1	1	1	1	1	1	1	1

		ØDe mm							
		230	250	280	300	350	400	450	500
GALVA	Ref.	4012524	4012525	-	-	-	-	-	-
	€ U.	1	1	-	-	-	-	-	-

Ref.	4500381	Unidades de embalaje Packing units Unités d'emballage
€ U.	1	

450	500	550	600
4500388	4500389	4500390	4500391
1	1	1	1

583	633	683	733
663	713	763	813

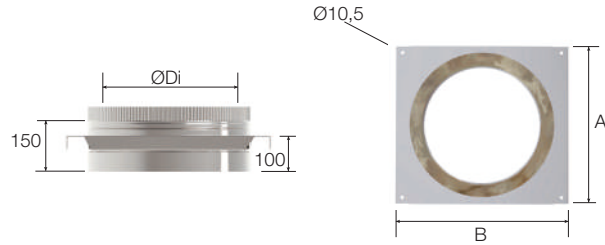

450	500	550	600
4026064	4026066	4026067	4026069
1	1	1	1

585	635	685	735
665	715	765	815
550	600	650	700

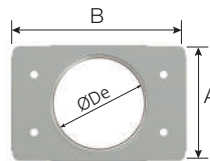

Escuadra de soporte reforzada (2 unidades) | Reinforced square support (2 units) | Équerre de support renforcé (2 unités)



AISI 304	Ref.	L	500 mm	750 mm	1000 mm	
		€ Kit	5003914	5003915	5003916	1
Medidas Measurements Mesures						
	H	310	470	600		

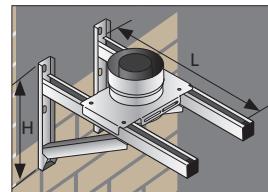

Escuadra reforzada con soporte mural
Reinforced square with wall support
Support renforcé avec support mural

* Apta para Soporte mural universal e intermedio | Suitable for universal and intermediate wall supports | Convient pour le Support mural universel et intermédiaire

450	500	550	600
4040056	4040057	4040058	4040059
1	1	1	1

-	-	-	-
-	-	-	-

550	600	650	700
-----	-----	-----	-----

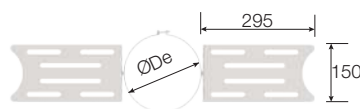

Abrazadera forjado | Ceiling bracket | *Collier support plancher*



		ØDi mm							
		130	150	180	200	250	300	350	400
AISI 304	Ref.	5001470	5001471	5001474	5001456	5001472	5001473	5001475	5001476
	€ U.	1	1	1	1	1	1	1	1
		ØDe							
		230	250	280	300	350	400	450	500

Abrazadera forjado reforzada | Reinforced ceiling bracket | *Collier support plancher renforcé*



		ØDi mm							
		130	150	180	200	250	300	350	400
AISI 304	Ref.	4026829	4023222	4026830	4023223	4023224	4023225	4023226	4026831
	€ U.	1	1	1	1	1	1	1	1
Medidas Measurements Mesures									
A		103	103	138	138	138	138	138	173
B		250	250	300	300	300	300	300	350
		ØDe							
		230	250	280	300	350	400	450	500

Abrazadera forjado universal | Universal ceiling bracket | *Collier support plancher universel* *



		ØDi mm							
		130	150	180	200	250	300	350	400
AISI 304	Ref.	4026043	4026044	4026045	4026046	4026048	4026080	4026081	4026082
	€ U.	1	1	1	1	1	1	1	1
		ØDe							
		230	250	280	300	350	400	450	500

Ref.	5001471	Unidades de embalaje Packing units Unités d'emballage
€ U.	1	

450	500	550	600
5001477	5001478	5001479	5001480
1	1	1	1
550	600	650	700

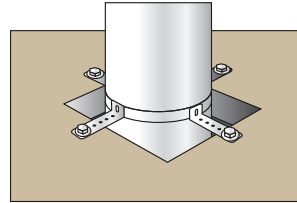
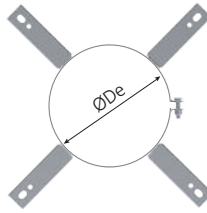

450	500	550	600
4026832	4026833	4026834	4026835
1	1	1	1
173	173	173	173
350	350	350	350
550	600	650	700

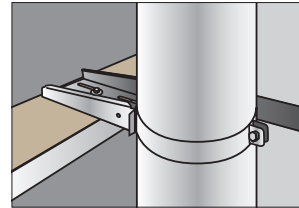
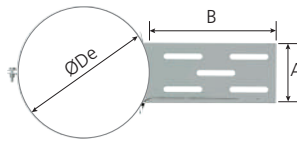

5

450	500	550	600
4040131	4040132	4040133	4040134
1	1	1	1
550	600	650	700

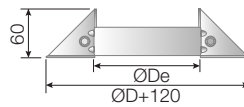

* Consultar las diferentes opciones de soporte en las páginas 133 y 143.
For support options, see pages 133 and 143.
Pour les options de support, voir pages 133 et 143.