

2 SP

Simple Pared
Single Wall
Simple Paroi

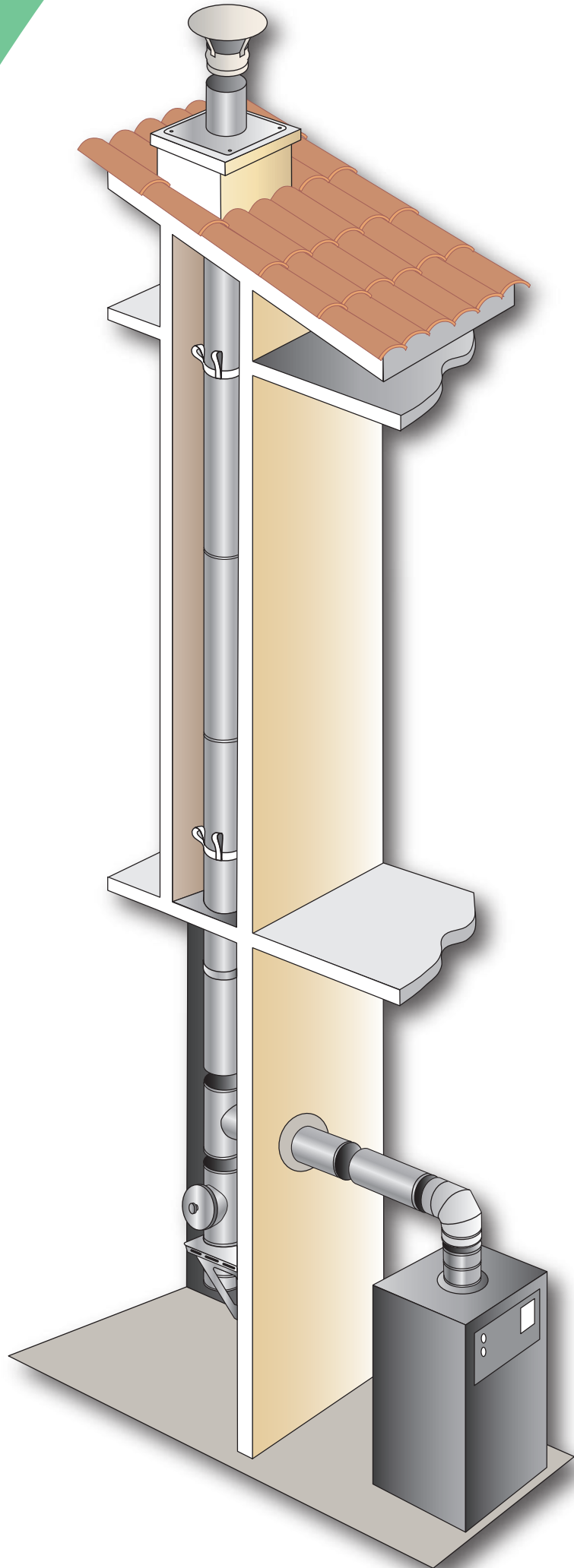



ROS Pellet

Núm. 14.2/22-2307_V1

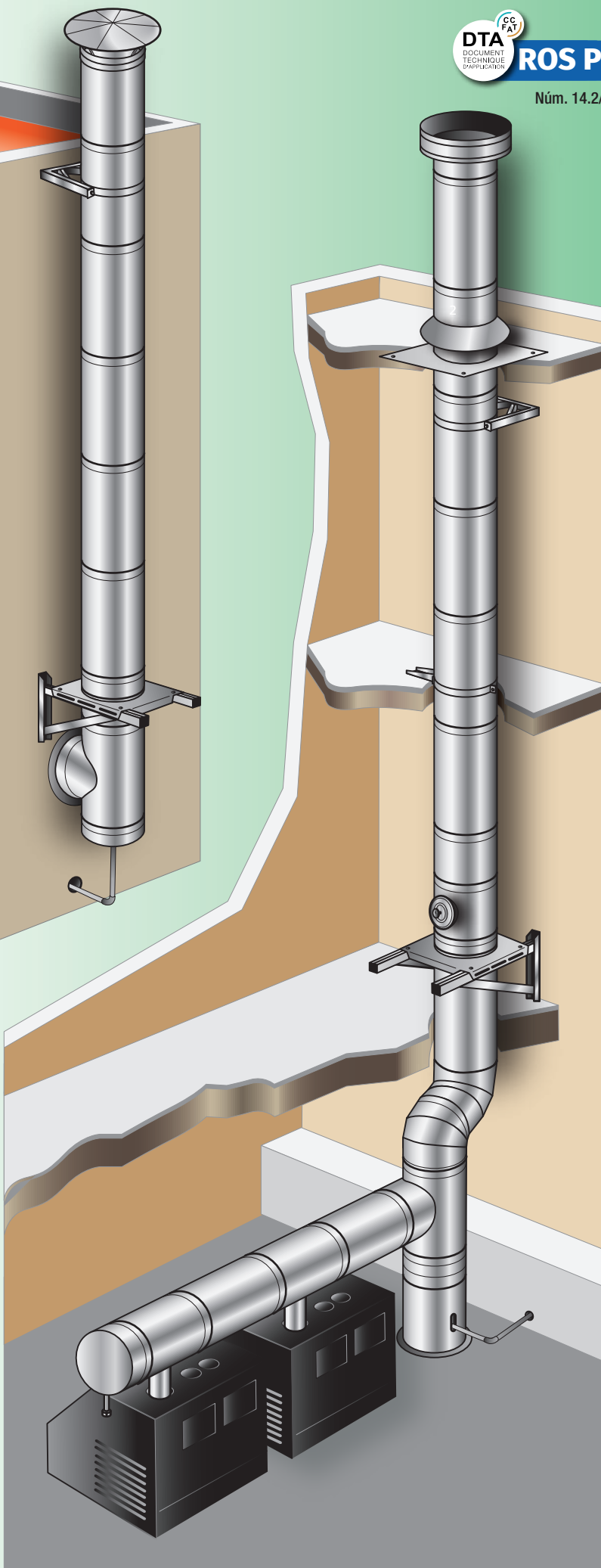

CE Especificaciones de acuerdo a la legislación europea en productos de construcción **CPR**
Specifications according to EU product regulations of construction **CPR**
Spécifications Selon la réglementation européenne concernant les produits de construction **CPR**

Espeor		Ø80-250	0,4 mm
Thickness		Ø300-400	0,5 mm
Épaisseur		Ø450-700	0,6 mm



AISI 304

(1.4301) **2R**

EN 1856-1

T200 P1 W Vm L20040 O(30)*

T200 N1 W Vm L20040 O(30)

T300 N1 W Vm L20040 O(75)

EN 1856-2

T200 P1 W Vm L20040 O(30)M*

T200 N1 W Vm L20040 O(30)M

T600 N1 W Vm L20040 G(600)M



AISI 316L

(1.4404) **2R**

EN 1856-1

T200 P1 W V2 L50040 O(30)*

T200 N1 W V2 L50040 O(30)

T300 N1 W V2 L50040 O(75)

EN 1856-2

T200 P1 W V2 L50040 O(30)M*

T200 N1 W V2 L50040 O(30)M

T600 N1 W V2 L50040 G(600)M

Notas: | Notes:

Para diámetros superiores a Ø300 mm, la distancia a los materiales combustibles se debe incrementar mediante un coeficiente.

For diameters more than Ø300 mm, the distance to combustible materials must be increased by a coefficient.

Pour les diamètres supérieurs à Ø300 mm, la distance par rapport aux matériaux combustibles doit être augmentée par un coefficient.

XX Distancia Distance:	x1,5 (Ø350-450)
	x2 (Ø500-600)
	x3 (Ø650-700)

* Para cumplir con esta designación todos los elementos deben estar instalados con juntas, consulte la página 54. Para saber el número de juntas, consulte la página 142. Para el resto de elementos, la junta es opcional.

* To comply with this designation, all elements must be installed with gaskets, see page 54. For the number of gaskets, see page 142. For all other elements, the gasket is optional.

* Pour respecter cette désignation, tous les éléments doivent être installés avec des joints, voir page 54. Unités de joints par élément, voir page 142. Pour tous les autres éléments, le joint est optionnel.

Módulo lineal | Linear module | Élément droit



ØD mm 80 100 110 125 130 150 180 200 230 250

L 1000 mm

AISI 304	Ref.	2700475	2700044	4022225	4013882	2700130	2700199	2700250	2700308	4007270	2700368
	€/u U.	6	6	6	6	6	6	6	2	1	1
AISI 316L	Ref.	4600000**	4600001**	4019524	4016243	4008382	4009355	4009356	4009357	4009358	4009359
	€/u U.	6	6	6	6	6	6	6	6	2	1

L 500mm

AISI 304	Ref.	2700474	2700043	4022224	4013494	2700129	2700198	2700249	2700307	4007271	2700367
	€/u U.	4	4	4	4	4	4	4	4	2	1
AISI 316L	Ref.	4600020**	4600021**	4019523	4016244	4014912	4014981	4016245	4014390	4016246	4013700
	€/u U.	4	4	4	4	4	4	4	4	2	1

L 250 mm

AISI 304	Ref.	2700473	2700042	4022223	4013493	2700128	2700197	2700248	2700306	4007422	2700366
	€/u U.	4	4	4	4	4	4	4	4	2	1
AISI 316L	Ref.	4600030**	4016229**	4019522	4016230	4015437	4016231	4016232	4014829	4016233	4016234
	€/u U.	4	4	4	4	4	4	4	4	2	1

Módulo extensible | Extendable module | Élément télescopique



ØD mm 80 100 110 125 130 150 180 200 230 250

Lmin 500 mm - Lmax 900 mm

AISI 304	Ref.	4022230	4022231	4022232	4013522	2700127	2700636	2700982	2700304	4022351	2700616
	€/u U.	2	2	2	2	2	2	2	2	1	1
AISI 316L	Ref.	4600070**	4600071**	4022301	4016650	4016652	4016653	4015914	4014801	4022352	4016654
	€/u U.	2	2	2	2	2	2	2	2	1	1

Lmin 335 mm - Lmax 565 mm

AISI 304	Ref.	2700788	2700041	4022229	4013521	2700126	2700196	2700246	2700302	4007710	2700364
	€/u U.	2	2	2	2	2	2	2	2	1	1
AISI 316L	Ref.	4010847**	4016643**	4019526	4016644	4014503	4014982	4016645	4014389	4016646	4014983
	€/u U.	2	2	2	2	2	2	2	2	1	1

Lmin 200 mm - Lmax 300 mm

AISI 304	Ref.	4015157	4012190	4022228	4013506	4007937	4008146	4008147	2700305	4012710	4007466
	€/u U.	2	2	2	2	2	2	2	2	1	1
AISI 316L	Ref.	4600060**	4600061**	4019525	4016634	4016635	4016636	4016637	4014802	4016638	4016639
	€/u U.	2	2	2	2	2	2	2	2	1	1

Tubo descenso | Down piping | Élément descente 1000 mm



		ØD mm	450	500	550	600	650	700
AISI 304	Ref.	4040109	4040110	4040111	4040112	4040113	4040114	
	€ U.	1	1	1	1	1	1	
AISI 316L	Ref.	4040115	4040116	4040117	4040118	4040119	4040120	
	€ U.	1	1	1	1	1	1	

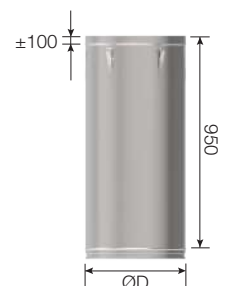

Ref.	2700199	Unidades de embalaje Packing units Unités d'emballage
€/u	6	



Abrazadera de unión incluida en todas las piezas.
Connection bracket included in all parts.
Collier de fixation inclus dans toutes les pièces.



Junta incluida.
Gasket included.
Joint inclus.

**** ø80 - 100**

300	350	400	450	500	550	600	650	700
-----	-----	-----	-----	-----	-----	-----	-----	-----

2700413	2700436	2700448	4029576	4029699	4029850	4030039	4030124	4040100
1	1	1	1	1	1	1	1	1
4009360	4009361	4009362	4028610	4029746	4029926	4030065	4030208	4040243
1	1	1	1	1	1	1	1	1

2700412	2700619	2700447	4029578	4029701	4029852	4030041	4030126	4040101
1	1	1	1	1	1	1	1	1
4015434	4016247	4016248	4029645	4029748	4029928	4030067	4030210	4040244
1	1	1	1	1	1	1	1	1

2700411	2700435	2700446	4029577	4029700	4029851	4030040	4030125	4040102
1	1	1	1	1	1	1	1	1
4015551	4016235	4016236	4029644	4029747	4029927	4030066	4030209	4040245
1	1	1	1	1	1	1	1	1

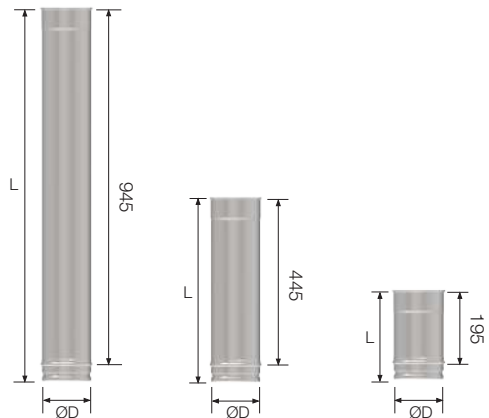

300	350	400	450	500	550	600	650	700
-----	-----	-----	-----	-----	-----	-----	-----	-----

2700594	4008023	4009335	4029565	4029684	4029825	4030026	4030112	4040105
1	1	1	1	1	1	1	1	1
4016655	4016656	4016657	4029628	4029732	4029899	4030050	4030142	4040108
1	1	1	1	1	1	1	1	1

2700410	2700434	2700444	4029564	4029683	4029824	4030025	4030111	4040104
1	1	1	1	1	1	1	1	1
4016647	4016648	4016649	4029627	4029724	4029898	4030049	4030141	4040107
1	1	1	1	1	1	1	1	1

4015158	4015159	4015160	4032467	4032468	4032469	4032470	4032471	4040103
1	1	1	1	1	1	1	1	1
4015537	4016640	4016642	4032472	4032473	4032474	4032475	4032476	4040106
1	1	1	1	1	1	1	1	1

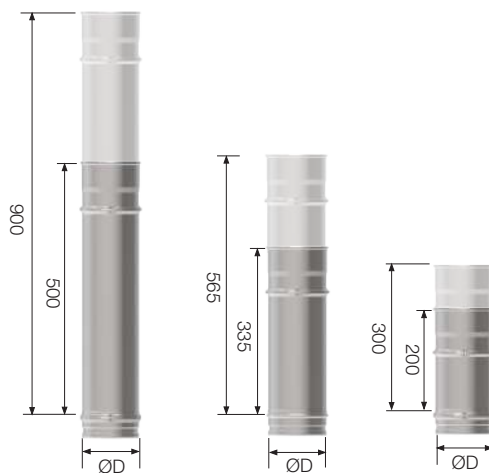

Codo | Elbow | Coude 15°



		ØD mm	80	100	110	125	130	150	180	200	230	250
AISI 304	Ref.		4022332	4022333	4022334	4022335	4022336	4022338	4022340	4022341	4022342	4022343
	€/u U.		4	4	4	4	4	4	4	4	1	1
AISI 316L	Ref.		4019654**	4019656**	4019658	4020155	4019659	4019660	4019661	4019662	4020156	4019663
	€/u U.		4	4	4	4	4	4	4	4	1	1

Medidas | Measurements | Mesures

	H	21	21	21	22	22	22	23	23	23	24
V		114	117	118	120	121	123	127	130	133	136

Codo | Elbow | Coude 30°



		ØD mm	80	100	110	125	130	150	180	200	230	250
AISI 304	Ref.		4014431	4018796	4022349	4013535	4007665	2700631	2700981	4007664	4009540	2700355
	€/u U.		4	4	4	4	4	4	4	4	1	1
AISI 316L	Ref.		4015623**	4019645**	4019531	4016557	4016558	4014976	4016559	4014979	4016560	4014980
	€/u U.		4	4	4	4	4	4	4	4	1	1

Medidas | Measurements | Mesures

	H	43	44	45	46	46	48	50	51	53	54
V		111	117	119	123	124	129	136	141	148	153

Codo | Elbow | Coude 45°



		ØD mm	80	100	110	125	130	150	180	200	230	250
AISI 304	Ref.		2700468	2700036	4022350	4013536	2700122	2700191	2700242	2700296	4007272	2700356
	€/u U.		4	4	4	4	4	4	4	4	1	1
AISI 316L	Ref.		4600080**	4600081**	4019532	4016563	4014913	4014984	4016564	4014388	4016565	4014985
	€/u U.		4	4	4	4	4	4	4	4	1	1

Medidas | Measurements | Mesures

	H	63	66	67	69	70	73	76	79	83	86
V		116	123	126	131	133	140	149	156	167	173

Codo | Elbow | Coude 87°



		ØD mm	80	100	110	125	130	150	180	200	230	250
AISI 304	Ref.		2700469	2700037	9022075	4013537	2700123	2700192	2700243	2700298	4022284	2700358
	€/u U.		4	4	4	4	4	4	4	4	1	1
AISI 316L	Ref.		4600090**	4600091**	4019533	4016567	4014915	4010654	4016556	4014800	4022285	4014986
	€/u U.		4	4	4	4	4	4	4	4	1	1

Medidas | Measurements | Mesures

	H	138	148	153	161	163	173	187	197	212	222
V		91	100	105	112	115	124	137	147	161	170

Codo con soporte | Elbow with bracket | Coude avec support 87°



		ØD mm	80	100	110	125	130	150	180	200	230	250
AISI 316L	Ref.		4019930**	4019931**	4019932	4022288	4019933	4019934	4019935	4019936	4022295	4019937
	€/u U.		4	4	4	4	4	4	4	4	1	1

Medidas | Measurements | Mesures

	H	98	108	113	120	123	133	147	157	172	182
V1		133	143	148	155	157	167	180	189	204	213
V2		191	211	221	236	241	263	291	311	341	359
A		96	112	120	132	136	158	180	196	220	239

Ref.	2700631	Unidades de embalaje Packing units Unités d'emballage
€/u	4	



Abrazadera de unión incluida en todas las piezas.
Connection bracket included in all parts.
Collier de fixation inclus dans toutes les pièces.



Junta incluida.
Gasket included.
Joint inclus.

**** ø80 - 100**

300	350	400	450	500	550	600	650	700
4022344	4022345	4025190	4029559	4029679	4029818	4030016	4030107	4040121
1	1	1	1	1	1	1	1	1
4019664	4019665	4025191	4029617	4029719	4029868	4030045	4030135	4040125
1	1	1	1	1	1	1	1	1

25	25	26	43	44	45	46	47	48
142	149	155	282	288	295	301	308	314

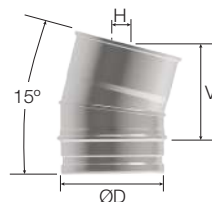

300	350	400	450	500	550	600	650	700
4008150	4009541	4028109	4029560	4029680	4029819	4030018	4030108	4040122
1	1	1	1	1	1	1	1	1
4016561	4016562	4029513	4029618	4029721	4029869	4030046	4030136	4040126
1	1	1	1	1	1	1	1	1

58	61	64	115	118	122	125	128	132
166	178	191	382	395	407	420	432	445

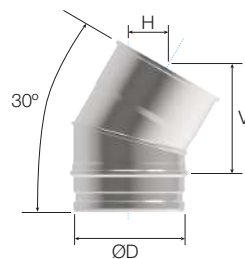

300	350	400	450	500	550	600	650	700
2700404	2700432	2700443	4029561	4029681	4029820	4030019	4030109	4040123
1	1	1	1	1	1	1	1	1
4015041	4013096	4016566	4029619	4029722	4029870	4030047	4030137	4040127
1	1	1	1	1	1	1	1	1

93	100	107	178	185	193	200	207	215
191	208	225	367	385	403	420	438	456

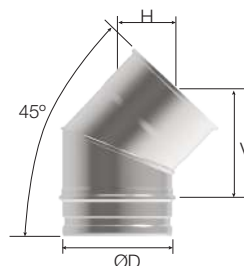

300	350	400	450	500	550	600	650	700
2700405	2700433	2700635	-	-	-	-	-	-
1	1	1	-	-	-	-	-	-
4015433	4016568	4016569	4029626	4029723	4029897	4030048	4030138	4040128
1	1	1	1	1	1	1	1	1

247	272	297	456	481	506	531	556	581
194	218	242	478	502	526	550	573	597

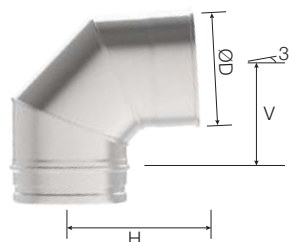

300	350	400
4019938	4019939	4019940
1	1	1

207	232	257
237	260	284
409	459	509
279	319	359

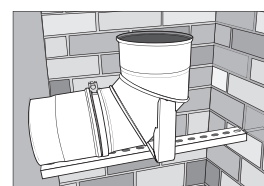
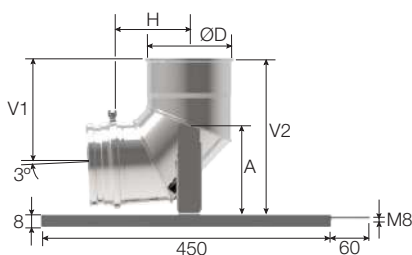

2

Te | "T" piece | Té 90° *



		ØD mm									
		80	100	110	125	130	150	180	200	230	250
AISI 304	Ref.	4022162	4022163	4022164	4022165	4022166	4022168	4022171	4022172	4022173	4022174
	€/u U.	3	3	3	3	3	2	2	2	1	1
AISI 316L	Ref.	4022035**	4022036**	4019527	4022037	4022038	4022040	4022042	4022043	4022045	4022047
	€/u U.	3	3	3	3	3	2	2	2	1	1
Medidas Measurements Mesures											
	H	90	100	105	113	115	125	139	149	164	174
	V	75	85	90	100	100	117	126	136	151	161
	L	193	213	223	243	243	276	293	313	343	363

Te | "T" Piece | Té 93° *



		ØD mm									
		80	100	110	125	130	150	180	200	230	250
AISI 304	Ref.	4019580	4019581	4022195	4019582	4019583	4019584	4019585	4019586	4019587	4019588
	€/u U.	3	3	3	3	3	2	2	2	1	1
AISI 316L	Ref.	4022073**	4022074**	9022076	9022077	4022078	4022080	4022082	4022083	4022084	4022085
	€/u U.	3	3	3	3	3	2	2	2	1	1
Medidas Measurements Mesures											
	H	92	103	108	116	119	129	144	154	170	181
	V	70	80	85	94	94	110	118	127	142	151
	L	193	213	223	243	243	276	293	313	343	363

Te | "T" Piece | Té 135° *



		ØD mm									
		80	100	110	125	130	150	180	200	230	250
AISI 304	Ref.	4022237	4022238	4022239	4022240	4022242	4022244	4018147	4022246	4022247	4022248
	€/u U.	2	2	2	2	2	2	2	2	1	1
AISI 316L	Ref.	4022250**	4022251**	4019528	4022254	4022255	4022257	4022262	4022264	4022265	4022269
	€/u U.	2	2	2	2	2	2	2	2	1	1
Medidas Measurements Mesures											
	H	111	128	137	149	154	171	195	212	237	254
	V	21	28	32	37	39	46	56	63	73	80
	L	227	256	270	291	298	326	366	394	437	465

Te base con tapa | Base "T" Piece with cap | Té base avec tampon 90°



		ØD mm							
		80	100	110	125	130	150	180	200
AISI 316L	Ref.	4021627**	4011365**	-	4034949	4034950	4034951	4034952	4034953
	€/u U.	1	1	-	1	1	1	1	1
Medidas Measurements Mesures									
	A	93	103	-	115	118	128	142	152
	L	237	237	-	245	272	287	320	337

Tapa | Cap | Tampon



		ØD mm									
		80	100	110	125	130	150	180	200	230	250
AISI 316L	Ref.	4010844	4015924	4019529	4015926	4015927	4014992	4015928	4014991	4016288	4014993
	€/u U.	4	4	4	4	4	4	4	4	1	1
Medidas Measurements Mesures											
	H	75	75	75	75	75	75	75	75	75	75

Tapa purga | Condensate cap | Tampon purge



		ØD mm									
		80	100	110	125	130	150	180	200	230	250
AISI 316L	Ref.	4015544	4015955	4019530	4015932	4014506	4015057	4015933	4014393	4022403	4014923
	€/u U.	4	4	4	4	4	4	4	4	1	1
Medidas Measurements Mesures											
	H	75	75	75	75	75	75	75	75	75	75
	ØG	1/2"	1/2"	1/2"	1/2"	1/2"	1/2"	3/4"	3/4"	3/4"	3/4"

Tapa purga lateral | Lateral condensate cap | Tampon purge latéral

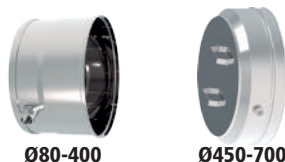

		ØD mm									
		80	100	110	125	130	150	180	200	230	250
AISI 316L	Ref.	4019678	4019680	4019691	4022405	4019692	4019693	4019694	4019695	4022408	4019696
	€/u U.	1	1	1	1	1	1	1	1	1	1
Medidas Measurements Mesures											
	H	95	95	95	95	95	95	95	95	95	95
	ØG	1/2"	1/2"	1/2"	1/2"	1/2"	1/2"	3/4"	3/4"	3/4"	3/4"

Ref.	4022168	Unidades de embalaje Packing units Unités d'emballage
€/u	2	



Abrazadera de unión incluida en todas las piezas.
Connection bracket included in all parts.
Collier de fixation inclus dans toutes les pièces.



Junta incluida.
Gasket included.
Joint inclus.

**** ø80 - 100**

300	350	400	450	500	550	600	650	700
4022221	2700978	4009296	4029574	4029697	4029848	4030037	4030122	4040161
1	1	1	1	1	1	1	1	1
4022048	4022049	4022051	-	-	-	-	-	-
1	1	1	-	-	-	-	-	-

199	224	249	295	320	345	370	395	420
201	211	236	306	331	356	381	406	456
443	463	513	700	750	800	850	900	950

300	350	400	450	500	550	600	650	700
4019589	4019590	4019591	-	-	-	-	-	-
1	1	1	-	-	-	-	-	-
9022086	4022087	4022088	4029642	4029744	4029925	4030064	4030207	4040162
1	1	1	1	1	1	1	1	1

207	233	259	307	334	360	386	413	439
190	198	222	306	331	356	381	406	456
443	463	513	700	750	800	850	900	1000

300	350	400	450	500	550	600	650	700
4011126	4022249	4011173	4033789	4033790	4033791	4033792	4033793	4040163
1	1	1	1	1	1	1	1	1
4022271	4022272	4022273	4033794	4033795	4033796	4033797	4033798	4040164
1	1	1	1	1	1	1	1	1

297	340	382	464	492	519	583	611	638
98	116	133	189	201	213	238	251	263
536	606	677	850	900	950	1050	1100	1150

300	350	400	450	500	550	600	650	700
4015953	4015929	4015930	4029635	4029739	4029913	4030057	4030202	4040166
1	1	1	1	1	1	1	1	1
75	75	75	158	184	208	232	257	282

300	350	400	450	500	550	600	650	700
4015554	4015934	4015935	4029634	4029738	4029905	4030056	4030201	4040168
1	1	1	1	1	1	1	1	1
75	75	75	158	184	208	232	257	282
1"	1"	1"	1"	1"	1"	1"	1"	1"

300	350	400	450	500	550	600	650	700
4019697	4019698	4035156	4035165	4035166	4035167	4035168	4035169	4040169
1	1	1	1	1	1	1	1	1
95	95	95	158	184	208	232	257	282
1"	1"	1"	1"	1"	1"	1"	1"	1"

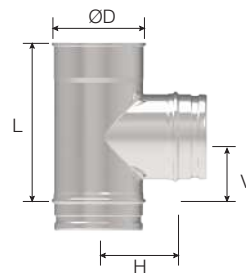

* No incluye tapa
Cover not included
Couvercle non inclus

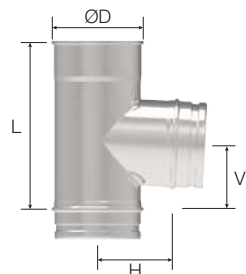

* No incluye tapa
Cover not included
Couvercle non inclus

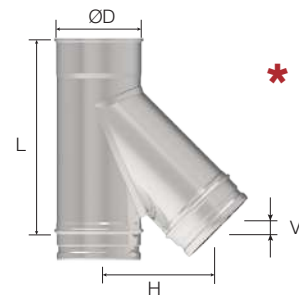

* No incluye tapa
Cover not included
Couvercle non inclus

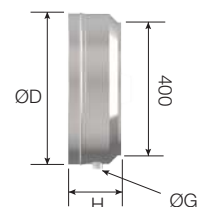
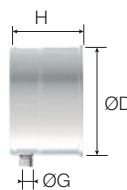
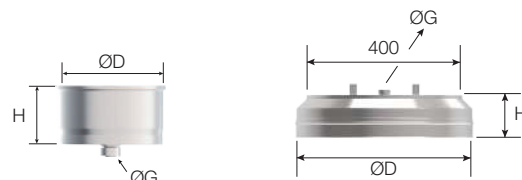
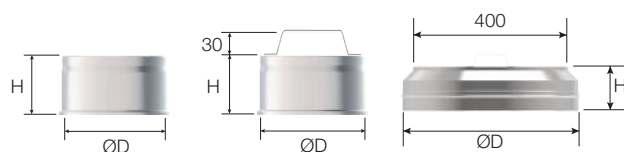
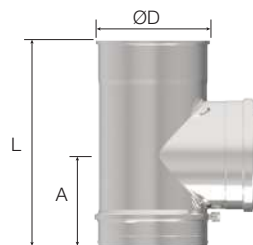

2

Módulo purga lateral | Lateral purge module | Module récupérateur condensats latérale



		ØD mm									
		80	100	110	125	130	150	180	200	230	250
AISI 316L	Ref.	4020210**	4020211**	-	4020212	4020213	4020214	4020215	4020216	4020217	4020218
	€ U.	1	1	-	1	1	1	1	1	1	1
Medidas Measurements Mesures											
		ØG	1/2"	1/2"	-	1/2"	1/2"	1/2"	3/4"	3/4"	3/4"

Regulador de tiro | Draft regulator | Modérateur de tirage

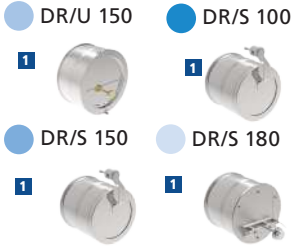

		ØD mm									
		80	100	110	125	130	150	180	200	230	250
AISI 304	Ref.	-	-	-	-	4025655	4025656	4025657	4025704	-	-
	€ U.	-	-	-	-	1	1	1	1	-	-
Medidas Measurements Mesures											
		DR/S 100				DR/S 150		DR/S 180			
AISI 304	Ref.	4025716	4025717	4025718	4025719	4025720	4025722	4025724	4025725	4025726	4025727
	€ U.	1	1	1	1	1	1	1	1	1	1

Módulo de limpieza oval con tapa | Oval cleaning module with cap | Module ramonage ovale avec trappe *



		ØD mm							
		80	100	110	125	130	150	180	200
AISI 316L	Ref.	-	4017160**	-	-	4017162	-	-	4017165
	€ U.	-	1	-	-	1	-	-	1

* Disponible hasta fin de existencias.
Available until stocks last.
Jusqu'à épuisement des stocks.

Módulo de inspección | Inspection module | Module inspection



		ØD mm									
		80	100	110	125	130	150	180	200	230	250
AISI 304	Ref.	4021835	4021836	4021837	4021838	4021839	4021840	4021841	4021842	4021843	4021844
	€ U.	1	1	1	1	1	1	1	1	1	1
AISI 316L	Ref.	4020116**	4020117**	4020118	4020157	4020119	4020120	4020121	4020122	4020158	4020123
	€ U.	1	1	1	1	1	1	1	1	1	1
Medidas Measurements Mesures											
		H	73	83	88	98	98	108	122	132	156
		L	194	214	223	244	244	277	294	314	343
		*ØT	80	100	110	130	130	150	180	200	250

Codo inspección | Inspection elbow | Coude inspection

87°



		ØD mm									
		80	100	110	125	130	150	180	200	230	250
AISI 316L	Ref.	4024385**	4024387**	-	4024390	4024391	4024392	4024393	4024394	-	4024395
	€ U.	1	1	-	1	1	1	1	1	-	1
Medidas Measurements Mesures											
		H	154	166	-	181	184	197	214	226	-
		V	119	132	-	148	152	165	182	195	-
		*ØT	80	100	-	130	130	150	180	200	-

Tapa de inspección | Inspection cover | Trappe d'inspection

200° C / 200 Pa

450° C / 40 Pa



Resistente a condensados
Condensate-resistant
Résistant aux condensats

Para combustibles sólidos
For solid fuels
Pour combustibles solides

		ØD mm									
		80	100	110	125	130	150	180	200	230	250
200° C / 200 Pa											
AISI 304	Ref.	5003265	5003266	5004391	5003267	5003267	5003268	5003269	5003270	5003270	5003271
	€ U.	1	1	1	1	1	1	1	1	1	1
450° C / 40 Pa											
AISI 304	Ref.	5003391	5003392	5004389	5003393	5003393	5003394	5003395	5003396	5003396	5003397
	€ U.	1	1	1	1	1	1	1	1	1	1
Medidas Measurements Mesures											
		ØT	80	100	110	130	130	150	180	200	250

Ref.	4020214	Unidades de embalaje Packing units Unités d'emballage
€ U.	1	



Abrazadera de unión incluida en todas las piezas.
Connection bracket included in all parts.
Collier de fixation inclus dans toutes les pièces.



Junta incluida.
Gasket included.
Joint inclus.

** **ø80 - 100**

300	350	400	450	500	550	600	650	700
4020219	4020220	4020221	4040209	4040210	4040211	4040212	4040213	4040214
1	1	1	1	1	1	1	1	1
1"	1"	1"	1"	1"	1"	1"	1"	1"

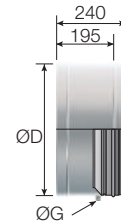
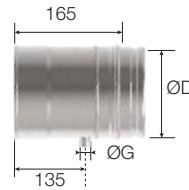

2

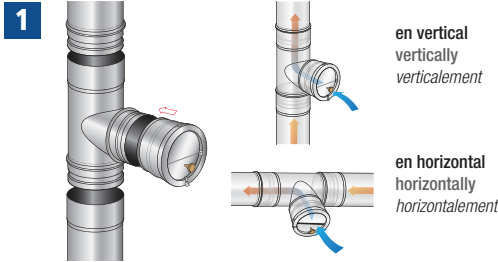

Montaje del regulador de tiro
Draft regulator assembly
Montage du modérateur de tirage

1 Montado en una Te de 90°. Vea la ilustración
Mounted on a 90° "T" Piece. See the image
Se monte sur un Té 90°. Voir illustration

Sifón | Siphon | Siphone

Ref.	4030741
€ U.	1

max. 160° C

300	350	400	450	500	550	600	650	700
4021845	4021846	4029517	4029566	4029685	4029840	4030027	4030113	4040182
1	1	1	1	1	1	1	1	1
4020124	4020125	4029516	4029629	4029733	4029900	4030051	4030147	4040183
1	1	1	1	1	1	1	1	1
182	216	241	275	300	325	350	375	400
444	464	514	455	455	455	455	455	455
300	300	300	300	300	300	300	300	300

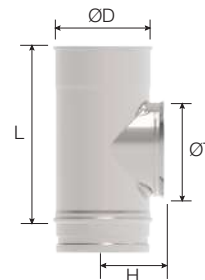
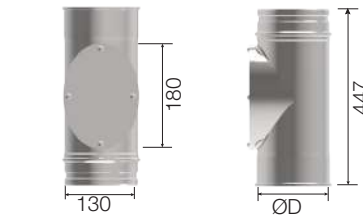

* No incluye tapa.
Cover not included.
Couvercle non inclus.

300	350	400	450	500	550	600	650	700
4017353	4033096	4033097	4033098	4033099	4033100	4033101	4033102	4040190
1	1	1	1	1	1	1	1	1
287	318	348	626	649	673	697	720	744
260	292	325	597	622	647	672	697	722
300	300	300	300	300	300	300	300	300

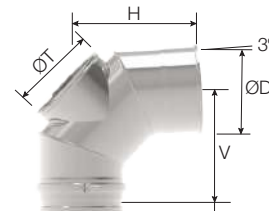

* No incluye tapa.
Cover not included.
Couvercle non inclus.

300	350	400	450	500	550	600	650	700
5003272								
1								
5003398								
1								
300								

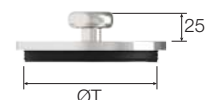
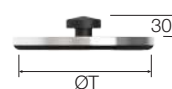

Módulo analizador gas | Gas analyzer module | Module analyseur de gaz



		ØD mm									
		80	100	110	125	130	150	180	200	230	250
AISI 304	Ref.	2700472	2700040	-	4013894	2700125	2700195	2700245	2700301	-	2700363
	€ U.	1	1	-	1	1	1	1	1	-	1
AISI 316L	Ref.	4010846**	4011364**	-	2700806	4014502	4019105	2700810	4016097	-	2700812
	€ U.	1	1	-	1	1	1	1	1	-	1

Módulo analizador gas y temperatura | Gas and temperature analyzer module | Module analyseur de gaz et de température *



		ØD mm									
		80	100	110	125	130	150	180	200	230	250
AISI 304	Ref.	4016715	4016716	-	4016717	4016718	4016719	4016720	4016721	-	4016722
	€ U.	1	1	-	1	1	1	1	1	-	1
AISI 316L	Ref.	4017170**	4017171**	-	4017172	4017173	4017174	4017175	4017177	-	4017178
	€ U.	1	1	-	1	1	1	1	1	-	1

* Pirómetro incluido | Pyrometer included | Pyromètre inclus

Módulo de condensados | Condensates module | Module de condensats



		ØD mm									
		80	100	110	125	130	150	180	200	230	250
AISI 316L	Ref.	4027439**	4027440**	4027441	4027442	4027443	4027445	4027447	4027448	4027449	4027450
	€ U.	1	1	1	1	1	1	1	1	1	1
Medidas Measurements Mesures											
ØG		1/2"	1/2"	1/2"	1/2"	1/2"	1/2"	3/4"	3/4"	3/4"	3/4"

Tubo recortable | Cut-out piping | Élément recoupable 1000 mm, 500 mm

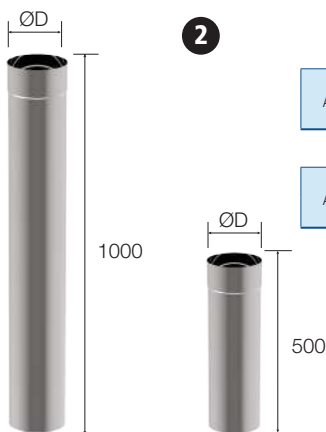

		ØD mm									
		80	100	110	125	130	150	180	200	230	250
L 1000 mm											
AISI 304	Ref.	4019893	4019894	4027456	4019895	4019895	4019896	4019897	4019898	4019899	4019900
	€ U.	1	1	1	1	1	1	1	1	1	1
L 500 mm											
AISI 304	Ref.	4019883	4019884	4027454	4019885	4019885	4019886	4019887	4019888	4019889	4019890
	€ U.	1	1	1	1	1	1	1	1	1	1

Base inicial con salida lateral | Floor base with lateral outlet | Plaque de départ avec sortie latérale



		ØD mm									
		80	100	110	125	130	150	180	200	230	250
AISI 304	Ref.	4021877	4027432	4027433	4021875	4021875	4021876	4019971	4019973	4019974	4019975
	€ U.	1	1	1	1	1	1	1	1	1	1

Ref.	4016719	Unidades de embalaje Packing units Unités d'emballage
€ U.	1	



Abrazadera de unión incluida en todas las piezas.
Connection bracket included in all parts.
Collier de fixation inclus dans toutes les pièces.



Junta incluida.
Gasket included.
Joint inclus.

**** ø80 - 100**

300	350	400	450	500	550	600	650	700
2700409	2700804	2700805	-	-	-	-	-	-
1	1	1	-	-	-	-	-	-
2700813	2700814	2700815	4040197	4040198	4040199	4040200	4040201	4040202
1	1	1	1	1	1	1	1	1



300	350	400
4016723	4016724	4016725
1	1	1
4017179	4017180	4017181
1	1	1



Pirómetro | Pyrometer | Pyromètre



Ref.	2500297
€ U.	1

0-500°C

300	350	400	450	500	550	600	650	700
4027451	4027452	4027453	4028611	4029740	4029922	4030058	4030203	4040307
1	1	1	1	1	1	1	1	1
1"	1"	1"	1"	1"	1"	1"	1"	1"

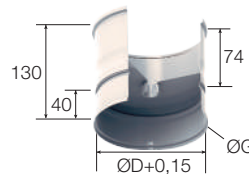

300	350	400	450	500	550	600	650	700
4019901	4022057	4022058	4028614	4040400	4040401	4040402	4040403	4040404
1	1	1	1	1	1	1	1	1
4019891	4022050	4022056	4040405	4040406	4040407	4040408	4040409	4040410
1	1	1	1	1	1	1	1	1

Alternativas de montaje de la base inicial

Alternative floor base mounting

Possibilités de montage de la plaque de départ au sol

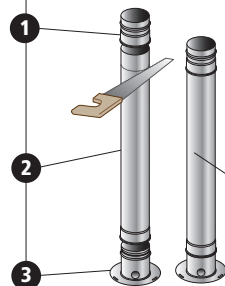

Montaje | Mounting | Montage 1

Con tubo recortable | With cut-out piping | Avec tuyau recoupable

El tubo recortable puede ser cortado a medida para que encaje perfectamente entre el suelo y la te de conexión a la caldera.

The cut-out piping can be cut to size for correct fitting between the floor and the boiler connection "T" Piece

L'élément recoupable peut être coupé sur mesure pour s'emboîter parfaitement entre le sol et le té de raccordement à la chaudière.

Montaje | Mounting | Montage 2

Sin tubo recortable

Without cut-out piping

Sans élément recoupable

300	350	400	450	500	550	600	650	700
4019977	4019978	4022033	4028612	4040412	4040413	4040414	4040415	4040416
1	1	1	1	1	1	1	1	1

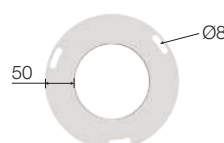

Soporte forjado | Ceiling support | Plaque plancher



		ØD mm									
		80	100	110	125	130	150	180	200	230	250
AISI 304	Ref.	2700974	2700967	4022028	4013905	2700968	2700969	2700970	2700971	4022328	2700972
	€ U.	1	1	1	1	1	1	1	1	1	1
AISI 316L	Ref.	4016373**	4016374**	4022326	4016375	4016376	4016377	4016378	4016379	4022327	4016380
	€ U.	1	1	1	1	1	1	1	1	1	1
Medidas Measurements Mesures											
□ A		330	350	360	375	380	400	430	450	480	500

Soporte forjado SP - DP | SW - DW Ceiling support | Plaque plancher SP - DP



		ØD mm									
		80	100	110	125	130	150	180	200	230	250
AISI 304	Ref.	4013071	4015135	-	4013970	4009216	4007590	4007591	4007592	-	4011056
	€ U.	1	1	-	1	1	1	1	1	-	1
AISI 316L	Ref.	4700730**	4016395**	-	4016396	4016399	4016400	4016401	4016402	-	4016403
	€ U.	1	1	-	1	1	1	1	1	-	1
Medidas Measurements Mesures											
□ A		330	350	360	375	380	400	430	450	480	500

Terminal obra ventilado con collarín | Ventilated end piece with storm collar | Solin toit plat ventilé avec collerette



		ØD mm									
		80	100	110	125	130	150	180	200	230	250
AISI 304	Ref.	4019701	4019705	4019707	4020159	4019708	4019709	4019710	4019711	4020160	4019712
	€ U.	1	1	1	1	1	1	1	1	1	1
□ A		395	395	395	395	395	395	450	450	450	495
ØDp		125	145	145	170	175	195	222	242	272	292

Terminal obra | End piece | Solin toit



		ØD mm									
		80	100	110	125	130	150	180	200	230	250
AISI 304	Ref.	4020097	4020098	4020099	4022440	4020100	4020101	4020102	4020103	4022433	4020104
	€ U.	1	1	1	1	1	1	1	1	1	1
Medidas Measurements Mesures											
□ A		390	390	390	390	390	390	390	450	450	495

Sombrero bicónico | Jet cap | Chapeau jet



		ØD mm					
		450	500	550	600	650	700
AISI 304	Ref.	4040191	4040192	4040193	4040194	4040195	4040196
	€ U.	1	1	1	1	1	1
Medidas Measurements Mesures							
ØDs		540	600	660	720	780	840
ØDc		790	885	980	1075	1140	1225
H		867	947	1027	1107	1188	1268

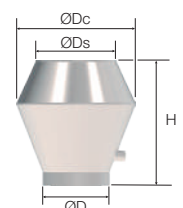

Ref.	2700969	Unidades de embalaje Packing units Unités d'emballage
€ U.	1	



Abrazadera de unión incluida en todas las piezas.
Connection bracket included in all parts.
Collier de fixation inclus dans toutes les pièces.



Junta incluida.
Gasket included. **** Ø80 - 100**
Joint inclus.

300	350	400
2700973	4022329	4022330
1	1	1
4016381	4016382	4022331
1	1	1
550	600	650

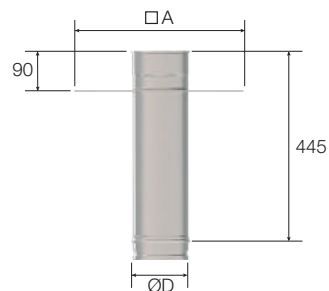

300	350	400
4015137	4015138	4015170
1	1	1
4016253	4016256	4015171
1	1	1
550	600	650

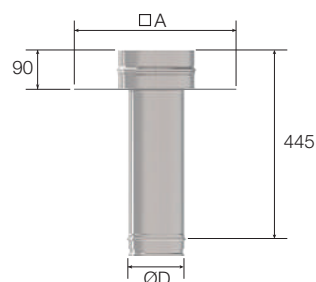

300	350	400
4019713	4019714	4019728
1	1	1
495	495	600
342	392	442

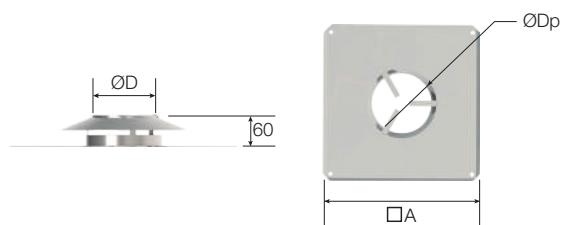

300	350	400
4020105	4020106	4019729
1	1	1
495	495	495



2

Sombrero antilluvia | Rain cap | *Chapeau pare-pluie*



*Opción antipájaros
*Bird guard option
*Option anti-volatile

		ØD mm									
		80	100	110	125	130	150	180	200	230	250
AISI 304	Ref.	2700476	2700045	4022481	4013733	2700132	2700200	2700251	2700309	4011596	2700369
	€ U.	1	1	1	1	1	1	1	1	1	1
AISI 316L	Ref.	4600330**	4600331**	4022482	4016429	4016430	4014987	4016431	4014988	4020676	4014989
	€ U.	1	1	1	1	1	1	1	1	1	1
AISI 316L*	Ref.	4016850**	4016851**	-	4016852	4016853	4016854	4016855	4016856	-	4016857
	€ U.	1	1	-	1	1	1	1	1	-	1
Medidas Measurements Mesures											
V		106	106	106	106	106	106	106	106	106	143
ØDp		250	250	250	300	300	300	350	350	400	450

Sombrero antirretorno | Non-return cap | *Chapeau anti-refoulement*



		ØD mm									
		80	100	110	125	130	150	180	200	230	250
AISI 304	Ref.	2700477	2700046	4022483	4013909	2700133	2700201	2700252	2700310	4011751	2700370
	€ U.	1	1	1	1	1	1	1	1	1	1
AISI 316L	Ref.	4600320**	4600321**	4022484	4016439	4016440	4016441	4016442	4016443	4022487	4016444
	€ U.	1	1	1	1	1	1	1	1	1	1
Medidas Measurements Mesures											
U		142	142	142	142	142	142	142	200	200	200
V		182	182	182	182	182	182	182	240	240	240
ØDp		180	200	210	230	230	250	280	350	380	400

Sombrero giratorio | Wind directional cap | *Chapeau aspirateur*



		ØD mm							
		125	130	150	180	200	250	300	350
AISI 304	Ref.	4013734	2500319	2500320	2500321	2500322	2500323	2700415	2700437
	€ U.	1	1	1	1	1	1	1	1
Medidas Measurements Mesures									
L		372	372	392	392	442	442	462	532
V		415	415	435	435	485	485	505	575
ØA		175	175	205	205	250	250	260	290

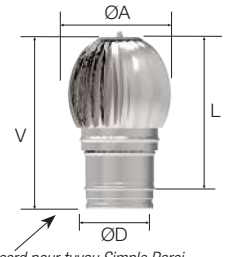

Unión para tubo Simple Pared | Single-wall piping connection | *Raccord pour tuyau Simple Paroi*

Sombrero salida libre | Exhaust high cone | *Cône de finition haute*



		ØD mm									
		80	100	110	125	130	150	180	200	230	250
AISI 304	Ref.	2700479	2700048	4022485	4013736	2700134	2700202	2700253	2700311	4022488	2700371
	€ U.	1	1	1	1	1	1	1	1	1	1
AISI 316L	Ref.	4600340**	4600341**	4022486	4016455	4014504	4015048	4016456	4014368	4022489	4013701
	€ U.	1	1	1	1	1	1	1	1	1	1

Sombrero salida vertical | Vertical outlet cap | *Chapeau sortie verticale*



		ØD mm									
		80	100	110	125	130	150	180	200	230	250
AISI 304	Ref.	4040062	4040063	-	4040065	4040066	2700659	2700658	2700657	-	2700656
	€ U.	1	1	-	1	1	1	1	1	-	1
AISI 316L	Ref.	4040069**	4040070**	-	4040072	4040073	4016477	4016478	4016480	-	4016481
	€ U.	1	1	-	1	1	1	1	1	-	1
Medidas Measurements Mesures											
L		283									
H		78	88	88	90	90	90	95	150	153	179

Sombrero salida horizontal | Horizontal outlet cap | *Chapeau sortie horizontale* 500 mm



		ØD mm					
		80	100	110	125	130	150
AISI 304	Ref.	2700478	2700047	4023531	4013735	4007269	4040060
	€ U.	1	1	1	1	1	1
AISI 316L	Ref.	4600350**	4016484**	4023533	4016485	4016486	4040061
	€ U.	1	1	1	1	1	1

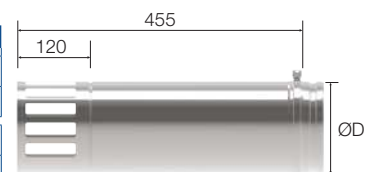

Sombrero pico flauta | Flute peak cap | *Chapeau de flûte*



		ØD mm									
		80	100	110	125	130	150	180	200	230	250
AISI 316L	Ref.	4007540**	4007541**	-	4007543	4007544	4007546	4007548	4010230	-	4014635
	€ U.	1	1	-	1	1	1	1	1	-	1

Ref.	2700202	Unidades de embalaje Packing units Unités d'emballage
€ U.	1	



Abrazadera de unión incluida en todas las piezas.
Connection bracket included in all parts.
Collier de fixation inclus dans toutes les pièces.



Junta incluida.
Gasket included.
Joint inclus.

** **ø80 - 100**

300	350	400	450	500	550	600	650	700
2700414	2700586	2700880	4029567	4029686	4029841	4030028	4030114	4040227
1	1	1	1	1	1	1	1	1
4015435	4016432	4016433	4029630	4029734	4029901	4030052	4030149	4040228
1	1	1	1	1	1	1	1	1
4016858	-	-	-	-	-	-	-	-
1	-	-	-	-	-	-	-	-

143	143	143	150	200	200	200	300	300
500	550	600	800	900	990	990	1300	1300

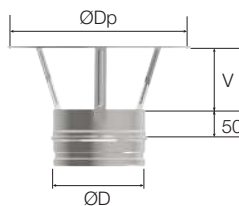

300	350	400	450	500	550	600	650	700
4010181	2700882	2700595	4040231	4040232	4040233	4040234	4040235	4040236
1	1	1	1	1	1	1	1	1
4016445	4016446	4016447	4040237	4040238	4040239	4040240	4040241	4040242
1	1	1	1	1	1	1	1	1

200	200	200	500	500	500	500	500	500
240	240	240	595	595	595	595	595	595
450	500	550	650	700	750	800	850	900



Sombrero giratorio universal | Universal wind-directional cap | Chapeau aspirateur universel



ØD mm	125	130	150	180	200	250	300	350
AISI 304 Ref.	-	3032088	3034036	3034041	3034042	3034043	3034044	3034045
€ U.	-	1	1	1	1	1	1	1
Medidas Measurements Mesures								
V	-	287	307	307	357	357	377	447
ØA	-	175	205	205	250	250	260	290

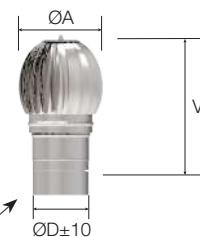

Unión para tubo liso | Smooth piping connection | Raccord pour tuyau lisse

300	350	400	450	500	550	600	650	700
2700593	2700438	4007438	4029569	4029692	4029843	4030030	4030117	4040129
1	1	1	1	1	1	1	1	1
4015042	4013101	4016457	4029632	4029736	4029903	4030054	4030151	4040130
1	1	1	1	1	1	1	1	1



300	350	400
4011811	4015665	4019424
1	1	1
4016482	4016483	4040077
1	1	1



445		
185	239	255

300	350	400	450	500	550	600	650	700
4012570	4020915	4007550	4007557	4007558	4007559	4007560	4007561	4007562
1	1	1	1	1	1	1	1	1

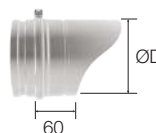

Adaptador caldera | Boiler adapter | *Adaptateur chaudière*



		ØD mm									
		80	100	110	125	130	150	180	200	230	250
AISI 304	Ref.	2700463	2700031	4022439	4013911	2700116	2700185	2700237	2700291	4022443	2700732
	€/u U.	4	4	4	4	4	4	4	4	1	1
AISI 316L	Ref.	4010848	4016593	4022442	4016594	4016595	4016596	4016597	4016598	4022445	4016599
	€/u U.	4	4	4	4	4	4	4	4	1	1

Adaptador caldera antihollín | Anti-soot boiler adapter | *Adaptateur chaudière anti-bistre*



		ØD mm									
		80	100	110	125	130	150	180	200	230	250
AISI 316L	Ref.	-	4025397	4025399	4025400	4025401	4025403	4025406	4025407	4025408	4025409
	€/u U.	-	4	4	4	4	4	4	4	1	1
Medidas Measurements Mesures											
ØDi		-	80	90	105	110	132	158	178	208	228
ØDe		-	102	112	127	132	152	182	202	232	252

Adaptador SP - DP | SW - DW Adapter | *Adaptateur SP - DP*



		ØD mm									
		80	100	110	125	130	150	180	200	230	250
AISI 304	Ref.	4007484	2700013	4022451	4013792	2700092	2700160	2700213	2700262	-	2700322
	€/u U.	1	1	1	1	1	1	1	1	-	1
AISI 316L	Ref.	4700545**	4700546**	4022452	4016602	4015766	4014568	4015915	4014579	-	4014569
	€/u U.	1	1	1	1	1	1	1	1	-	1

Adaptador Macho SP - Pestaña SP | SW male - SW lip adapter | *Adaptateur Mâle SP - bord tombé SP **



		ØD mm									
		80	100	110	125	130	150	180	200	230	250
AISI 316L	Ref.	4040640	4040641	4040642	4040643	4040644	4040645	4040646	4040647	-	4040648
	€/u U.	1	1	1	1	1	1	1	1	-	1

Adaptador Hembra SP - Pestaña SP | SW female - SW lip adapter | *Adaptateur Femelle SP - bord tombé SP*



		ØD mm									
		80	100	110	125	130	150	180	200	230	250
AISI 316L	Ref.	4040600	4040601	4040602	4040603	4040604	4040605	4040606	4040607	-	4040608
	€/u U.	1	1	1	1	1	1	1	1	-	1

Adaptador Macho - Macho | Male - Male Adapter | *Adaptateur Mâle - Mâle*



		ØD mm									
		80	100	110	125	130	150	180	200	230	250
AISI 304	Ref.	2700465	2700033	4022478	4013912	2700119	2700188	2700239	2700293	2700525	2700352
	€/u U.	4	4	4	4	4	4	4	4	1	1
AISI 316L	Ref.	4010845**	4016603**	4022479	4016604	4016605	4014994	4016606	4016607	4016608	4016609
	€/u U.	4	4	4	4	4	4	4	4	1	1

Adaptador Hembra - Hembra | Female - Female Adapter | *Adaptateur Femelle - Femelle*



		ØD mm									
		80	100	110	125	130	150	180	200	230	250
AISI 304	Ref.	2700464	2700032	4022476	4013913	2700118	2700187	2700238	2700292	4014532	2700351
	€/u U.	4	4	4	4	4	4	4	4	1	1
AISI 316L	Ref.	4009592	4015046	4022477	4016612	4016613	4014990	4016614	4016615	4022480	4016616
	€/u U.	4	4	4	4	4	4	4	4	1	1

Paso mural | Wall bushing | *Traversée de mur*



		ØD mm									
		80	100	110	125	130	150	180	200	230	250
AISI 316L	Ref.	4019781	4019782	4019783	-	4019784	4019785	4019786	4019787	-	4019788
	€/u U.	4	4	4	-	4	4	4	4	-	1

Ref.	2700185	Unidades de embalaje Packing units Unités d'emballage
€/u	4	



Abrazadera de unión incluida en todas las piezas.
Connection bracket included in all parts.
Collier de fixation inclus dans toutes les pièces.



Junta incluida.
Gasket included.
Joint inclus.

**** ø80 - 100**

300	350	400	450	500	550	600	650	700
2700399	4030562	4029553	4029554	4029675	4029813	4030013	4030104	4040135
1	1	1	1	1	1	1	1	1
4016600	4030563	4029555	4029556	4029703	4029853	4030042	4030127	4040136
1	1	1	1	1	1	1	1	1

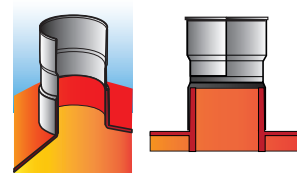
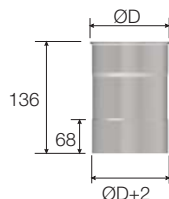

2

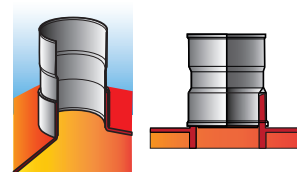
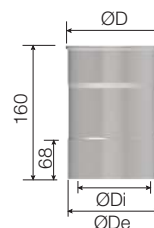

300	350	400	450	500	550	600	650
2700825	4008960	4027340	4029558	4029678	4029817	4030015	4030106
1	1	1	1	1	1	1	1
4023385	4014405	4028927	4029616	4029705	4029865	4030044	4030134
1	1	1	1	1	1	1	1

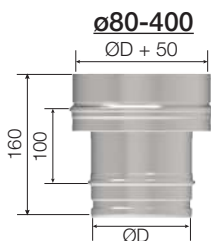

ø450 - 700

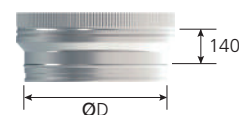

300	350	400
4040649	4040650	4040651
1	1	1

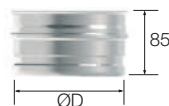

*** Incluye Abrazadera unión tornillo**
Connection bracket, screwed included
Collier de fixation à vis inclus

300	350	400
4040609	4040610	4040611
1	1	1

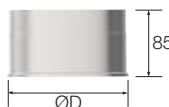

300	350	400	450	500	550	600	650	700
2700401	4008295	4011679	4040149	4040150	4040151	4040152	4040153	4040154
1	1	1	1	1	1	1	1	1
4016610	4016611	4040015	4040155	4040156	4040157	4040158	4040159	4040160
1	1	1	1	1	1	1	1	1

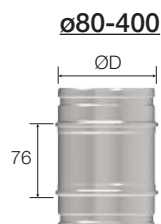

ø450 - 700

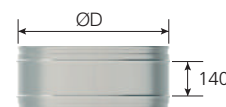

300	350	400	450	500	550	600	650	700
2700400	2700431	4009297	4040137	4040138	4040139	4040140	4040141	4040142
1	1	1	1	1	1	1	1	1
4016617	4016618	4040016	4040143	4040144	4040145	4040146	4040147	4040148
1	1	1	1	1	1	1	1	1

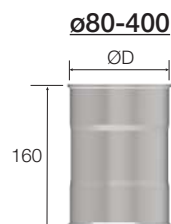

ø450 - 700

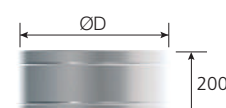

300	350	400
4019789	4019790	4019791
1	1	1

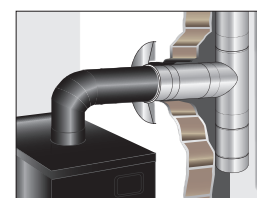
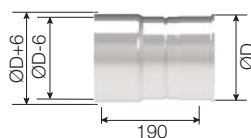

SP

Simple Pared | Single Wall | Simple Paredi

Ø80-700

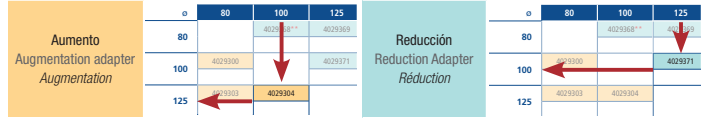

Aumento - Reducción | Augmentation adapter - Reduction adapter | Augmentation · Réduction

Ø	80	100	110	125	130	150	180	200	230	250	300	350	400	450	500	550	600	650	700	
80		4022589**	4022591	4022598	4022607															
100	4600404**		4022590	4022596	4015436	4022631	4022658													
110	4022510	4022513		4022593	4022602	4022629	4022657													
125	4020560	4022514	4022517		4022599	4022628	4022655	4022663												
130	4014505	4015045	4022520	4018342		4015653	4022651	4022662	4022674											
150	4017721	4022516	4022525	4022528	4022533		4015654	4022660	4022671	4018425										
180				4022530	4022554	4022564		4015655	4022668	4022678										
200		4030132		4022531	4022555	4015882	4022571		4022664	4015656	4022683									
230							4022572	4022575		4022676	4022681									
250						4022566	4022573	4022276	4022578		4015657	4022694	4022685							
300							4022574	4022576	4022579	4022581		4022687	4022686	4040768						
350								4022577	4022580	4022582	4022583		4022697	4040769	4040770					
400										4009573	4011762	4008962		4040771	4040772	4040773				
450											4040762	4040763	4040750		4040774	4040775	4040776			
500												4040764	4040751	4040753		4040777	4040778	4040779		
550													4040752	4040754	4040756		4040780	4040781	4040782	
600														4040755	4040757	4040759		4040783	4040784	
650															4040758	4040760	4040761			4040785
700																4040765	4040766	4040767		



L mm	øDi mm																			
	80	100	110	125	130	150	180	200	230	250	300	350	400	450	500	550	600	650	700	
80		141	159	187	197															
100	141		110	150	159	197	248													
110	159	110		110	110	178	230													
125	187	150	110		110	150	202	240												
130	197	159	110	110		141	193	230	286											
150	234	197	178	150	110		155	193	249	286										
180				202	193	155		141	197	234										
200		280		240	230	193	141		160	197	290									
230							197	160		141	234									
250						153	234	197	141		197	290	383							
300							164	154	234	197		234	287	180						
350								179	164	154	234		197	155	180					
400									179	154	197		130	156	180					
450										186	161	136		134	160	185				
500											186	162	134		134	160	185			
550												186	160	134		134	160	185		
600													185	160	134		134	160		
650														160	160	134			134	
700															185	160	134			

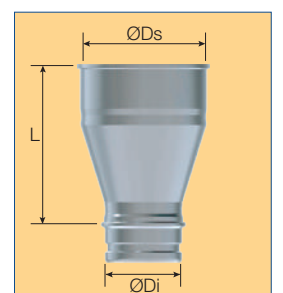
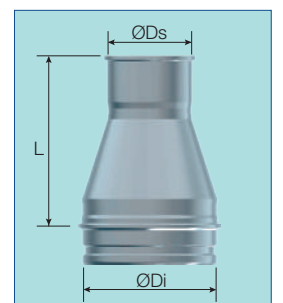



Abrazadera de unión incluida en todas las piezas.
Connection bracket included in all parts.
Collier de fixation inclus dans toutes les pièces.



Junta incluida.
Gasket included.
Joint inclus. **** ø80 - 100**

Material: | Material: | Matériel : **AISI 316L**

Unidades de embalaje: | Packing units: | Unités d'emballage : **1**

Aumento y reducción excéntrica | Eccentric augmentation adapter and reduction adapter | *Augmentation et réduction excentrées*

Ø	80	100	110	125	130	150	180	200	230	250	300	350	400	450	500	550	600	650	700	
80		4029179**	4029180	4029182	4029183															
100	4028780**			4029186	4029187	4029192	4029194													
110	4029062			4029195	4029196	4029200	4029206													
125	4029063	4029067	4029079			4029210	4029212	4029213												
130	4029064	4029068	4029081			4029215	4029217	4029218												
150	4029066	4029070	4029084	4029088	4029093		4029224	4029225	4029226	4029227										
180				4029090	4029115	4029123		4029232	4029233	4029234										
200				4029091	4029116	4029124	4029136		4029235	4029236	4029237									
230						4029125	4029137	4029139		4029239	4029240									
250						4029126	4029138	4029140	4029145		4029242	4029243	4029244							
300							4029141	4029142	4029146	4029148		4029245	4029246	4040815						
350								4029144	4029147	4029173	4029176		4029247	4040816	4040817					
400										4029175	4029177	4029178		4040803	4040804	4040806				
450											4040797	4040798	4040786		4040805	4040807	4040809			
500												4040799	4040266	4040787		4040808	4040810	4040812		
550													4040788	4040789	4040790		4040811	4040813	4040819	
600														4040791	4040792	4040793		4040814	4040818	
650															4040794	4040795	4040796		4040820	
700																4040800	4040801	4040802		

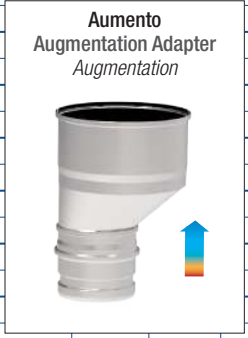

2

L mm	øDi mm																			
	80	100	110	125	130	150	180	200	230	250	300	350	400	450	500	550	600	650	700	
80		121	129	147	147															
100	121			125	129	147	171													
110	129			117	121	138	162													
125	147	125	117			125	149	167												
130	147	129	121			121	145	162												
150	164	147	138	125	121		128	145	171	188										
180				149	145	128		121	147	164										
200				167	162	145	121		130	147	190									
230						171	147	130		121	164									
250						188	164	147	121		147	190	233							
300							208	190	164	147		147	207	235						
350								233	207	190	147		147	192	235					
400									233	190	147		149	192	235					
450										235	192	149		153	196	240				
500											235	192	153		153	197	240			
550												235	197	153		153	197	240		
600													240	197	153		153	197		
650														240	197	153		153		
700															240	197	153			

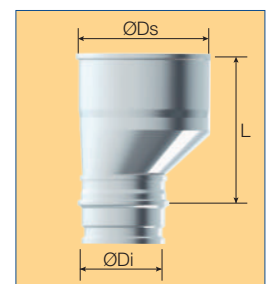
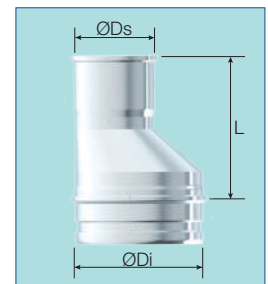

Abrazadera mural interior | Interior wall bracket | Collier support mural intérieur *



		ØD mm									
		80	100	110	125	130	150	180	200	230	250
AISI 304	Ref.	2500046	2500037	5003875	4013902	2500038	2500039	2500040	2500041	5001351	2500042
	€/u	6	6	6	6	6	6	6	6	2	2
Medidas Measurements Mesures											
A		120	120	120	150	150	150	190	190	190	230

* Opción regulable: añadir Prolongación mural (ver pág. 132)
Adjustable option: add Wall extension (see page 132)
Option réglable: ajouter Rallonge murale (voir page 132)

Abrazadera pared regulable | Adjustable wall bracket | Collier mural réglable *



		ØD mm									
		80	100	110	125	130	150	180	200	230	250
AISI 304	Ref.	4600700	4600701	5003876	4600702	4600707	4600703	4600705	4600704	4600708	4600706
	€/u	1	1	1	1	1	1	1	1	1	1
Medidas Measurements Mesures											
A		156	156	156	186	186	186	226	226	226	266

* Opción regulable: añadir Prolongación mural (ver pág. 132)
Adjustable option: add Wall extension (see page 132)
Option réglable: ajouter Rallonge murale (voir page 132)

Abrazadera atornillar | Screwed bracket | Collier à vis



		ØD mm					
		80	100	110	125	130	150
AISI 304	Ref.	2500026	2500023	5003877	4013908	2500024	2500025
	€/u	1	1	1	1	1	1

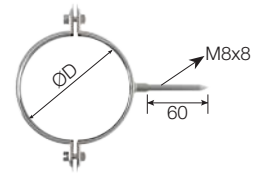

Abrazadera de vientos | Roof brace band | Collier pour hauban



		ØD mm									
		80	100	110	125	130	150	180	200	230	250
AISI 304	Ref.	2700467	2700035	4019537	4013907	2700121	2700190	2700241	2700295	2700214	2700354
	€/u	3	3	3	3	3	3	3	3	1	1

Abrazadera descenso | Chimney-lowering bracket | Collier de descente



		ØD mm									
		80	100	110	125	130	150	180	200	230	250
AISI 304	Ref.	4035095	4035096	-	4035111	4035097	4035098	4035099	4035100	4035101	4035102
	€/u	1	1	-	1	1	1	1	1	1	1

Abrazadera araña | Spider bracket | Bride araignée



		ØD mm									
		80	100	110	125	130	150	180	200	230	250
AISI 304	Ref.	4008372	4018448	4018693	4018695	4013533	4009721	4012491	4016687	4027251	4025629
	€/u	1	1	1	1	1	1	1	1	1	1

Abrazadera de suspensión horizontal | Horizontal suspension bracket | Collier de suspension horizontale



		ØD mm									
		80	100	110	125	130	150	180	200	230	250
AISI 304	Ref.	-	-	-	-	-	-	5005630	5005631	5005632	5005633
	€/u	-	-	-	-	-	-	1	1	1	1

* No incluye varillas de fijación ni tornillería necesaria | Fixing rods and necessary screws not included |
Tiges de fixation et vis nécessaires non incluses

Ref.	2500039	Unidades de embalaje Packing units Unités d'emballage
€/u	6	

300	350	400	450	500	550	600	650	700
2500043	2500510	2500044	4035019	4035066	4035067	4035068	4035069	4035070
2	2	2	1	1	1	1	1	1
230	300	300	-	-	-	-	-	-

300	350	400
4600709	4600710	4600711
1	1	1
266	336	336

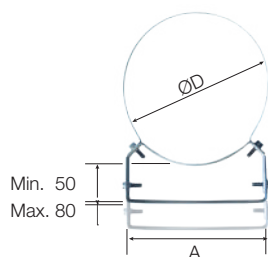
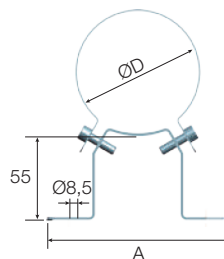

300	350	400	450	500	550	600	650	700
2700403	2700323	2700418	4014608	4014609	4014610	4014611	4014612	4014613
1	1	1	1	1	1	1	1	1



300	350	400	450	500	550	600	650	700
4035103	4035104	4035105	4040417	4040418	4040419	4040420	4040421	4040422
1	1	1	1	1	1	1	1	1

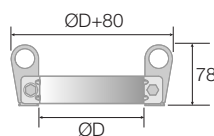

300	350	400	450	500	550	600	650	700
4016411	4016412	4016414	4040203	4040204	4040205	4040206	4040207	4040208
1	1	1	1	1	1	1	1	1

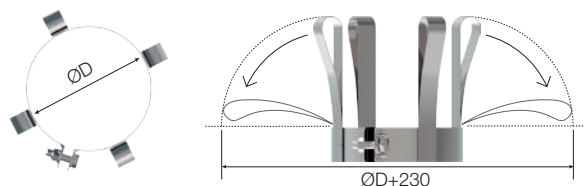

300	350	400	450	500	550	600	650	700
5005634	5005635	5005636	5005637	5005638	5005639	5005640	5005641	5005642
1	1	1	1	1	1	1	1	1

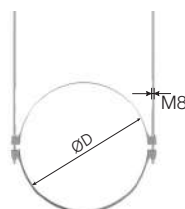

2

Soporte mural intermedio | Intermediate wall support | Support mural intermédiaire *



ØD mm		80	100	110	125	130	150	180	200	230	250
AISI 304	Ref.	4020313	4020315	4022425	4020316	4020317	4020318	4020319	4020320	4022429	4020321
	€ U.	1	1	1	1	1	1	1	1	1	1
AISI 316L	Ref.	4023689**	4023690**	4023691	4023692	4023693	4023695	4023697	4023698	4023699	4023700
	€ U.	1	1	1	1	1	1	1	1	1	1

Medidas | Measurements | Mesures

	A	115	135	145	160	165	185	213	233	263	283
	B	195	215	225	240	245	265	293	313	343	363

* No incluye escuadras | Square supports not included | Équerres de support non inclus

Soporte mural universal | Universal wall support | Support mural universel *

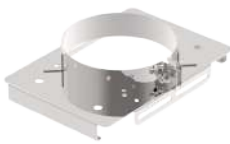

ØD mm		80	100	110	125	130	150	180	200	230	250
AISI 304	Ref.	-	-	-	4028317	4026049	4026050	4026051	4026052	4026053	4026054
	€ U.	-	-	-	1	1	1	1	1	1	1

Medidas | Measurements | Mesures

	A	-	-	-	165	165	185	213	233	263	283
	B	-	-	-	245	245	265	293	313	343	363

* No incluye escuadras | Square supports not included | Équerres de support non inclus

Escuadra de soporte (2 unidades) | Square support (2 units) | Équerre de support (2 unités)



		Pequeña* Small* Petit*	Mediana* Medium* Moyen*	Grande* Large* Grand*
AISI 304	Ref.	4019925	4019926	4019927
	€ Kit	1	1	1

Medidas | Measurements | Mesures

	L	245	360	515
	H	290	430	610

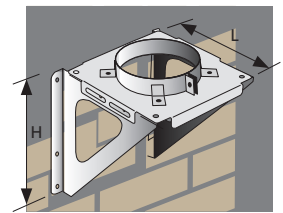

Escuadra con soporte mural
Square with wall support
Équerre avec support mural

* Consultar el tamaño adecuado en la página 143 | Refer to the appropriate size on page 143 | Voir la taille appropriée à la page 143

Escuadra de soporte reforzada (2 unidades) | Reinforced square support (2 units) | Équerre de support renforcé (2 unités)



		L	500 mm	750 mm	1000 mm
AISI 304	Ref.	5003914	5003915	5003916	
	€ U.	1	1	1	

Medidas | Measurements | Mesures

	H	310	470	600
--	---	-----	-----	-----

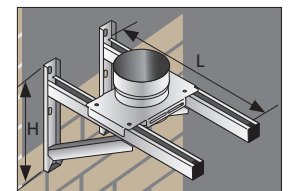

Escuadra reforzada con soporte mural
Reinforced square with wall support
Support renforcé avec support mural

* Apto para Soporte mural universal e intermedio | Suitable for universal and intermediate wall supports | Convient pour le Support mural universel et intermédiaire

Abrazadera de unión tornillo | Connection bracket, screwed | Collier de fixation à vis



ØD mm		80	100	110	125	130	150	180	200	230	250
AISI 304	Ref.	5003964	5003965	5003966	5004280	5003967	5003968	5003969	5003970	5003971	5003972
	€/u U.	10	10	10	10	10	10	10	10	10	10

Junta silicona | Silicone gasket | Joint silicone 200° C



ØD mm		80	100	110	125	130	150	180	200	230	250
Ref.		5003948	5003950	5004278	5003951	5003951	5003952	5003953	5003954	5003956	5003957
€/u	U.	10	10	10	10	10	10	10	10	10	10

Junta cerámica autoadhesiva | Self-adhesive ceramic gasket | Joint autoadhésif en céramique 600° C



Ref.		Medidas Measurements Mesures					
Ref.	2053351						
€/m	m.						
		Ø m	80	100	110	125	130
		m (desarrollo unfolding déroulage)	0,25	0,31	0,35	0,39	0,41

Ref.	4020318	Unidades de embalaje Packing units Unités d'emballage
€/u	1	



Abrazadera de unión incluida en todas las piezas.
Connection bracket included in all parts.
Collier de fixation inclus dans toutes les pièces.



Junta incluida.
Gasket included.
Joint inclus.

**** ø80 - 100**

300	350	400	450	500	550	600	650	700
4020322	4020323	4020324	4029570	4029693	4029844	4030032	4030118	4040229
1	1	1	1	1	1	1	1	1
4023701	4023702	4023703	4029633	4029737	4029904	4030055	4030200	4040230
1	1	1	1	1	1	1	1	1
333	383	433	567	617	667	717	767	817
413	463	513	613	663	713	763	813	863

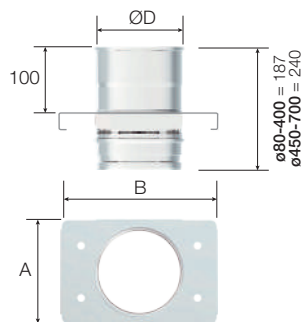

300	350	400	450	500	550	600	650	700
4026059	4026060	4026061	4026062	4026063	4026064	4026066	4026067	4026069
1	1	1	1	1	1	1	1	1
333	383	435	485	535	585	635	685	735
413	463	515	565	615	665	715	765	815

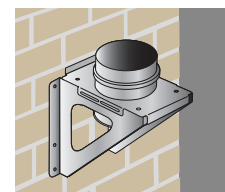
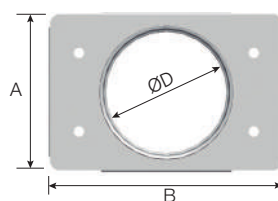

Escuadra con soporte mural intermedio
Square with intermediate wall support
Èquerre avec support mural intermédiaire

Rosetón blanco | White Rosette | Rosace blanche EPDM



	80	100	125
Ref.	5005897	5005899	2700131
€/u	1	1	1

300	350	400	450	500	550	600	650	700
5003973	5003974	5003975	5004828	5004829	5004830	5004831	5004832	5004833
5	5	5	1	1	1	1	1	1

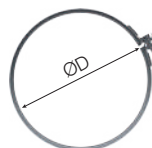

300	350	400	450	500	550	600	650	700
5003958	5003959	5003960	5005716	5005717	5005718	5005719	5005720	5005721
5	5	5	1	1	1	1	1	1

Lubricante silicona | Silicone lubricant | Graisse silicone



150ml

Ref.	5002932
€/u	1

150	180	200	230	250	300	350	400
0,47	0,57	0,63	0,72	0,79	0,94	1,10	1,26

2

Soporte pared regulable | Adjustable wall support | Support mural réglable



		ØD mm									
		80	100	110	125	130	150	180	200	230	250
AISI 304	Ref.	4600718	4600719	-	4600720	4600725	4600721	4600722	4600723	4600726	4600724
	€ U.	1	1	-	1	1	1	1	1	1	1
Medidas Measurements Mesures											
A		133	153	-	178	183	203	232	252	282	302
B		190	210	-	234	240	260	290	310	340	360

Soporte a techo regulable | Adjustable ceiling mounting | Support au toit réglable



		ØD mm									
		80	100	110	125	130	150	180	200	230	250
AISI 304	Ref.	-	-	-	-	4013467	4014952	4013529	4012519	4013295	4012428
	€ U.	-	-	-	-	1	1	1	1	1	1
GALVA	Ref.	-	-	-	-	4012520	4012521	-	4012523	4012524	4012525
	€ U.	-	-	-	-	1	1	-	1	1	1

Abrazadera forjado | Ceiling bracket | Collier support plancher



		ØD mm									
		80	100	110	125	130	150	180	200	230	250
AISI 304	Ref.	4022020	4022021	4022022	4028373	4022023	4022025	4022027	4011861	5001470	5001471
	€ U.	1	1	1	1	1	1	1	1	1	1

Abrazadera forjado reforzada | Reinforced ceiling bracket | Collier support plancher renforcé



		ØD mm									
		80	100	110	125	130	150	180	200	230	250
AISI 304	Ref.	-	-	-	4028374	4026828	9023220	4026934	9023221	4026829	4023222
	€ U.	-	-	-	1	1	1	1	1	1	1
Medidas Measurements Mesures											
A		-	-	-	103	103	103	103	103	103	103
B		-	-	-	250	250	250	250	250	250	250

Abrazadera forjado universal | Universal ceiling bracket | Collier support plancher universel *



		ØD mm									
		80	100	110	125	130	150	180	200	230	250
AISI 304	Ref.	-	-	-	4028318	4026043	4026044	4026045	4026046	4026047	4026048
	€ U.	-	-	-	1	1	1	1	1	1	1

Ref.	4600721	Unidades de embalaje Packing units Unités d'emballage
€ U.	1	

300	350	400
4600727	4600728	4600729
1	1	1

351	401	452
408	458	508

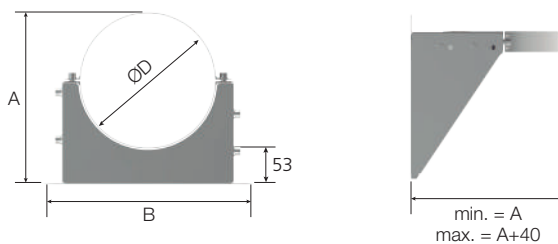

2

300	350	400	450	500	550	600	650	700
4015588	4015660	4014552	4040054	4040055	4040056	4040057	4040058	4040059
1	1	1	1	1	1	1	1	1
-	-	-	-	-	-	-	-	-
-	-	-	-	-	-	-	-	-

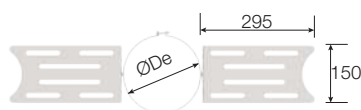

300	350	400	450	500	550	600	650	700
5001456	5001472	5001473	5001475	5001476	5001477	5001478	5001479	5001480
1	1	1	1	1	1	1	1	1

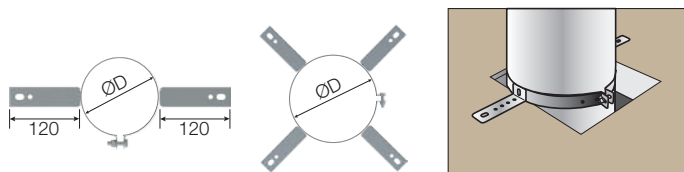

300	350	400	450	500	550	600	650	700
4023223	4023224	4023225	4023226	4026831	4026832	4026833	4026834	4026835
1	1	1	1	1	1	1	1	1

138	138	138	138	173	173	173	173	173
300	300	300	300	350	350	350	350	350

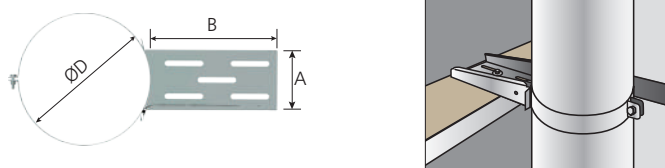

300	350	400	450	500	550	600	650	700
4026080	4026081	4026082	4040131	4040132	4040133	4040134	4040215	4040216
1	1	1	1	1	1	1	1	1

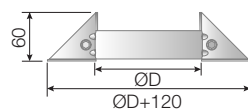

* Consultar las diferentes opciones de soporte en las páginas 133 y 143.
For support options, see pages 133 and 143.
Pour les options de support, voir pages 133 et 143.